



Grove Manitowoc National Crane Potain

Manitowoc 14000

Product Guide

ASME B30.5

Metric / Imperial



Features

- 200 t (220 USt) capacity
- 865 m-ton (6,267 ft-kips) maximum load moment
- 89 m (292 ft) heavy-lift boom
- 98,4 m (323 ft) fixed jib on heavy-lift boom
- 113,8 m (373 ft) luffing jib on heavy-lift boom
- 253 kW (340 HP) engine

Features

EPIC®

Manitowoc's field-proven Electronically Processed Independent Controls (EPIC) system delivers high productivity and precise load control by instantly matching a crane's commands to the crane function. EPIC's microprocessor maximizes a Manitowoc crane's function capability and simplifies servicing by pinpointing any problem in the crane's engine, power transmission and other operating systems. In addition, EPIC increases versatility by easily tailoring a Manitowoc crane's operation for specialized applications, with or without attachments. EPIC is a key reason no other crane can match the performance and reliability of Manitowoc.

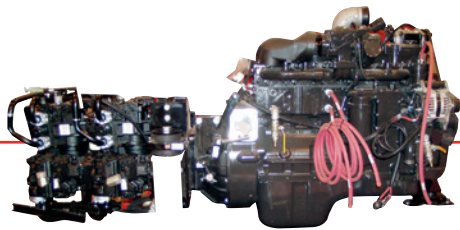

Hydraulics

Our closed-loop system provides a separate hydraulic circuit to power each crane function. The result is truly independent, variable-speed operation of the swing, load hoist, boom hoist and travel functions.



Crawler drive shafts

These eliminate the need to disconnect hydraulic systems for shipment—simplifying crawler removal and assembly.



FACT™ connectors

Manitowoc's Fast Aligning Connection Technology (FACT) precisely aligns crane components for safe, fast, easy assembly.

Contents

Specifications	4
Outline dimensions	7
Transport data	13
Crane assembly	14
Performance data	15
Boom combinations	20
Main boom range / load charts	23
Fixed jib range / load charts	25
Luffing jib range / load charts	28
Manitowoc Crane Care	32

Specifications

Upperworks



Engine

Cummins Model QSL 8.9 liter diesel, 6 cylinder, 253 kW (340 BHP) @ 1800 governed RPM.

Includes engine block heater (120 V), air heater starting aid (24 V), oil heater starting aid (120 V), high silencing muffler, radiator and fan.

Multiple hydraulic pump drive transmission provides independent power for all machine functions.

Two 12 volt maintenance-free, Group 8D batteries, 1375 CCA at -18°C (0° F), 24 volt starting and 70 amp alternator.

One 568 l (150 gal) capacity diesel fuel tank, mounted on right side of upperworks, with level indicator in operator's cab.



Controls

Modulating electronic-over-hydraulic controls provide infinite speed response directly proportional to control lever movement. Controls include Manitowoc's exclusive EPIC® Electronically Processed Independent Control system with CAN-BUS technology providing microprocessor driven control logic, pump control, on-board diagnostics, and service information.

Block-up limit control is standard for hoist and whip lines.

Rated Capacity Indicator system (RCI) is standard for main boom and upper boom point. "Function cut-out" or "warning only" operation is available via programmable configuration.

Travel and swing alarms are standard.



Hydraulic system

Six high-pressure piston pumps are driven through a multi-hydraulic pump transmission. These six pumps provide independent "closed loop" hydraulic power for front drum, rear drum, boom hoist system, swing system, and both left and right crawler operation.

Hydraulic reservoir capacity is 300 l (79.25 gal) and is equipped with breather, sight and electrical level indicator, clean out access, and internal diffuser.

Each function is equipped with relief valves to protect the hydraulic circuit from overload or shock.

Replaceable, ten micron (absolute) full flow tank filter is furnished in the hydraulic circuit. All oil is filtered prior to return to the hydraulic reservoir.

Hydraulic system also includes pump transmission disconnect clutch & hydraulic oil cooler.



Drums

Two equal width winches are driven by independent variable displacement axial piston hydraulic motors through planetary reduction mounted on separate front and rear shafts with anti-friction bearings. Drums are grooved for 26 mm rope.

Powered hoisting/lowering operation is standard with automatic (spring applied, hydraulically released) multi-disc brakes, and drum rotation indicators.

- Optional: free-fall operation for front and/or rear drums(s).
- Optional: auxiliary (third) hydraulic powered drum mounted in boom butt. Includes third drum control system. Auxiliary drum is used as the luffing hoist when machine is equipped with a luffing jib.
- Optional: auxiliary drum preparation includes electric wiring, controls, hydraulic selector valve and plumbing.



Boom hoist

Independent boom hoist consists of drum grooved for 22 mm diameter wire rope. Includes 22 mm diameter wire rope for 20 part line reeving.

Drum is powered by a variable displacement hydraulic motor coupled to an internal brake and planetary gearbox equipped with ratchet and pawl.



Mast and gantry

Moving mast is 8,2 m (27 ft) long and connects the boom hoist reeving to the steel boom suspension strap rigging. When used with optional self-erect package, the mast is utilized for crane assembly and disassembly. It is capable of lifting and positioning the crawler assemblies, stacking the counterweights and assembling the boom and jib.

Specifications

Gantry includes gantry raising cylinders capable of lifting the entire upperworks counterweight for removal and installation. Back hitch telescopes from storage to working position and is locked with power-actuated pins. Counterweight is suspended from gantry with straps.

Spring cushioned boom stop and automatic boom stop standard.

Counterweight

Qty.	Item	Unit weight		Total weight	
		kg	lb	kg	lb
1	Upperworks Tray	9 965	22,092	9 965	22,092
6	Upper Side Box	7 938	17,500	47 628	105,000
Series 1 Total		57 593		127,092	
1	Upperworks Center Box	2 680	5,908	2 680	5,908
2	Upper Side Box	7 938	17,500	15 876	35,000
2	Carbody Lower Box	12 020	26,500	24 040	53,000
Optional: add to Series 1 for		Series 2 Total		100 189 221,000	

Series 1 and Series 2 counterweight configurations. Includes connecting pins, brackets, and stops.

Swing system

High strength fabricated steel alloy rotating bed is mounted on 2,76 m (108-9/16") diameter turntable single-row ball bearing.

Independent swing powered by a fixed displacement hydraulic motor coupled to a planetary gearbox with internal brake.

Swing system maximum speed: 2.3 rpm.

Operator's cab

Fully enclosed and insulated galvanized steel module is equipped with sliding door, large safety glass windows on all sides and roof. Signal horn, cab space heater, front and roof windshield wipers, air conditioning, dome light, sun visor and shade, fire extinguisher and air circulating fan are standard.

- Optional: tilt cab.
- Optional: nylon protective window covers.

Lowerworks

Carbody

Connects rotating bed to crawler assemblies. High strength fabricated steel assembly with FACT™ connection system for safe fast installation and removal of crawler assemblies.

Crawlers

Crawler assemblies are 8,3 m (27' 2") long with 1,22 m (48") wide cast steel crawler pads. Each crawler is identical and can be mounted on either side of the carbody. Each crawler is powered independently by a variable displacement hydraulic motor and includes two hydraulically powered pin actuators for fast installation and removal from carbody. Carbody mounted drive motors are connected to crawler final reduction via telescoping shafts. This permits crawlers to be removed without opening their hydraulic circuits. Crawlers provide ample tractive effort that allows counter rotation with full rated load. Maximum ground speed of 1,8 kph (1.1 mph).

- Optional: self-erect system includes: carbody jacking cylinders with pads, controls, 27,2 t (30 USt) assembly block, boom-butt installation support, gantry cylinders and crawler handling chain.

Attachments

No. 76 heavy-lift main boom

The liftcrane is equipped with a 20 m (65.6') No. 76 basic heavy-lift tubular chord boom consisting of a 5,5 m (18') butt, 5,5 m (18') insert, and 9 m (30') top with seven 76,2 cm (30") diameter roller bearing sheaves in 3 sheave packs. Includes rope guides, boom hoist wire rope, and boom angle indicator. The No. 76 boom utilizes steel suspension straps and Manitowoc's exclusive FACT™ connection system.

Powered boom hinge system including cylinder, piping, operating controls and locking device standard.

Luffing jib preparation included as standard.

- Optional: 3,0 m (10'), 6 m (19'), and 12 m (39') No. 76 boom inserts with steel boom suspension straps, and FACT™ connection system.

Specifications



No. 134 fixed jib

- Optional: No. 134 basic tubular chord fixed jib 9,1 m (30') in length consisting of 4,6 m (15') jib butt and 4,6 m (15') jib top with 3,7 m (12') jib strut, pendants and backstay. Includes RCI hardware. For use with boom No. 76.
- Optional: No. 134 fixed jib inserts 3,0 m (10') and 6,1 m (20') with pendants.

Utilize fixed jib inserts in combination with the No. 134 basic fixed jib for total lengths up to 24,4 m (80').



No. 135 luffing jib

- Optional: 21,3 m (70') basic No. 135 tubular chord luffing jib assembly with RCI hardware consisting of 8,2 m (27') butt, 6,1 m (20') insert, and 7,0 m (23') top with two 68,6 cm (27") straight roller bearing sheaves and pin connected jib sections, pendants, fixed strut, jib strut, backstay pendants, boom point wheel, 26 mm luffing jib hoist line. For use with No. 76 boom.
- Optional: 3,0 m (10'), 6,1 m (20'), and 12,2 m (40') No. 135 inserts with pendants. Utilize luffing jib inserts in combination with the No. 135 basic luffing jib for total lengths up to 57,8 m (170').

Optional equipment

- Blocks and hooks –

13,6 t (15 USt) swivel hook and weight ball.

27,2 t (30 USt) hook block with one 76,2 cm (30") sheave for 26 mm wire rope with swivel hook, hook latch and swivel lock (assembly block).

54 t (60 USt) hook block with two 76,2 cm (30") sheaves for 26 mm wire rope with swivel hook, hook latch and swivel lock.

91 t (100 USt) hook block with three 76,2 cm (30") sheaves for 26 mm wire rope with duplex swivel hook, hook latch, and swivel lock.

150 t (165 USt) hook block with six 76,2 cm (30") sheaves for 26 mm wire rope with duplex swivel hook, hook latch, and swivel lock.

200 t (220 USt) hook block with seven 76,2 cm (30") sheaves for 26 mm wire rope with swivel hook, hook latch, and swivel lock.

- Hydraulic Test Kit.
- Service Interval Kits.
- Special Paint Color (other than Manitowoc standard red and black.)
- Special Customer Decals: custom vinyl decal(s) of name and/or logo from artwork supplied by customer.
- Export Packaging: basic crane, boom and jib sections.

Outline dimensions

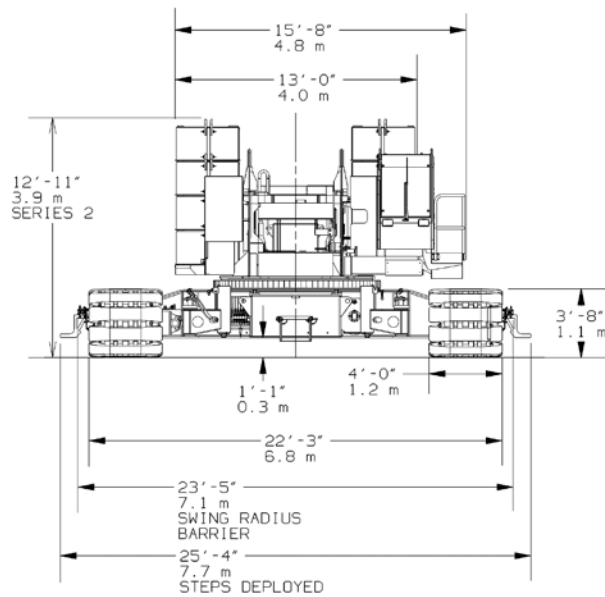
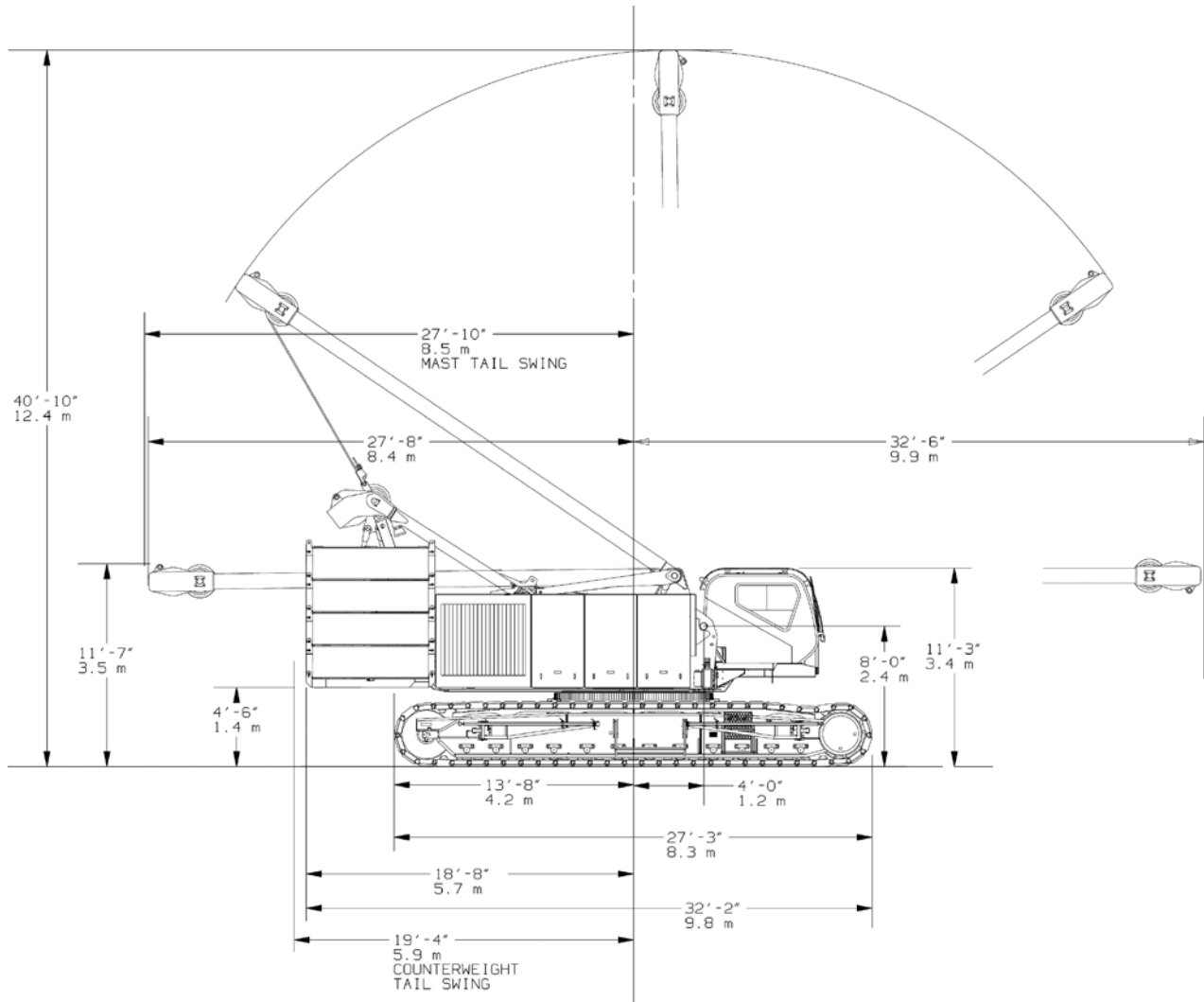

Outline dimensions

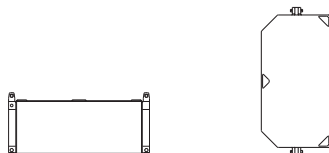
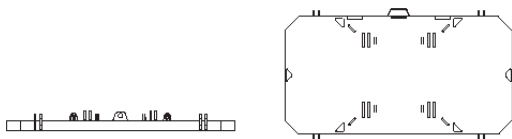
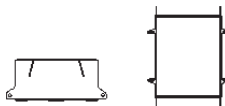
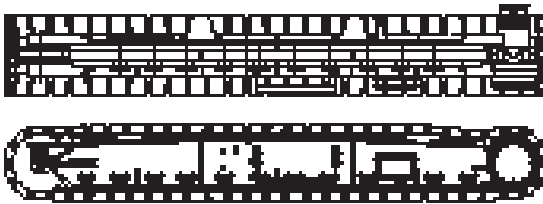
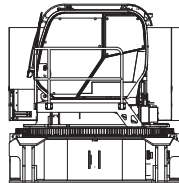
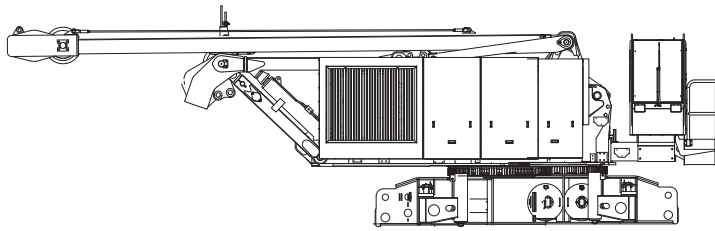

Basic crane

Length	11,63 m	38' 2"
Width	3,00 m	9' 10"
Height (CE pkg)	3,20 m	10' 6"
Height (non-CE pkg)	3,43 m	11' 3"
Weight	39 689 kg	87,500 lb

Note: Weight includes carbody, upperworks, operator's cab, gantry, backhitch, mast, boom-hoist wire rope, maximum hoist and whip lines on drums, optional self-assembly jacks, full hydraulic fluid reservoir, and half tank of fuel.

Crawlers

x 2

Length	8,31 m	27' 3"
Width	1,55 m	5' 1"
Height	1,14 m	3' 9"
Weight	17 706 kg	39,000 lb

Upper center counterweight

x 1

Length	1,30 m	4' 3"
Width	1,04 m	3' 5"
Height	0,56 m	1' 10"
Weight	2 680 kg	5,900 lb

Counterweight tray

x 1

Length	3,71 m	12' 2"
Width	2,36 m	7' 9"
Height	0,33 m	1' 1"
Weight	9 716 kg	21,400 lb

Upper side counterweight

Series 1

x 6

Series 2

x 8

Length	2,24 m	7' 4"
Width	1,07 m	3' 6"
Height	0,69 m	2' 3"
Weight	7 938 kg	17,500 lb

Option

Outline dimensions

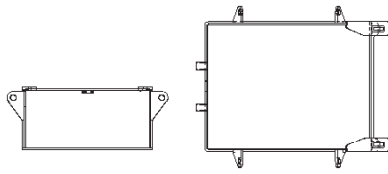

Lower carbody counterweight Series 2		
		x 2
Length	2,24 m	7' 4"
Width	1,85 m	6' 1"
Height	0,74 m	2' 5"
Weight	12 122 kg	26,700 lb

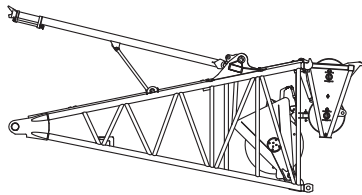

5,5 m (18.0 ft) No. 76 boom butt and wire rope guide, boom stop		
Length	6,76 m	22' 2"
Width	2,44 m	8' 0"
Height	2,64 m	8' 8"
Weight	2 860 kg	6,300 lb

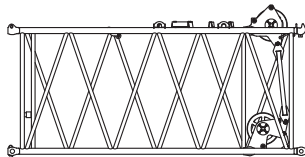

5,5 m (18.0 ft) No. 76 boom insert with sheaves		
Length	5,69 m	18' 8"
Width	2,54 m	8' 4"
Height	2,59 m	8' 6"
Weight	1 634 kg	3,600 lb

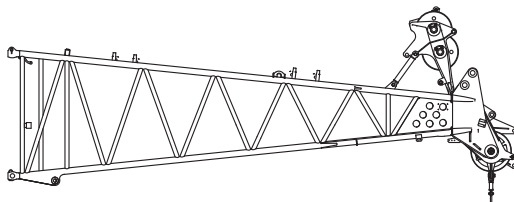

9,0 m (29.5 ft) No. 76 boom top and wire rope guide, straps		
Length	9,58 m	31' 5"
Width	2,51 m	8' 3"
Height	2,97 m	9' 9"
Weight	4 495 kg	9,900 lb

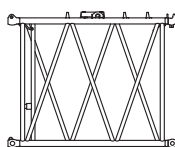

3,0 m (9.8 ft) No. 76 main boom insert and straps		
Length	3,17 m	10' 5"
Width	2,54 m	8' 4"
Height	2,59 m	8' 6"
Weight	772 kg	1,700 lb

Option

Outline dimensions

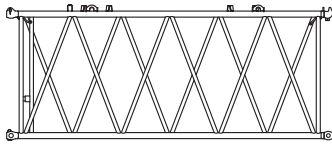

6,0 m (19.7 ft) No. 76 main boom insert and straps

Length	6,17 m	20' 3"
Width	2,54 m	8' 4"
Height	2,59 m	8' 6"
Weight	1126 kg	2,700 lb

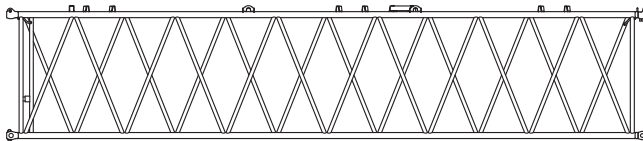

12,0 m (39.4 ft) No. 76 main boom insert and straps

Length	12,17 m	39' 11"
Width	2,54 m	8' 4"
Height	2,59 m	8' 6"
Weight	2134 kg	4,700 lb

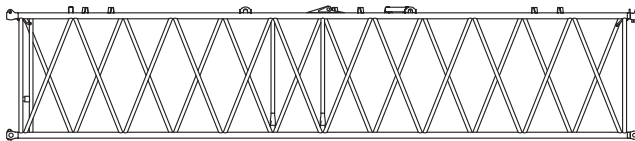

12,0 m (39.4 ft) No. 76 main boom with backstay insert and straps

Length	12,17 m	39' 11"
Width	2,54 m	8' 4"
Height	2,59 m	8' 6"
Weight	2179 kg	4,800 lb

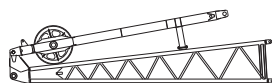

4,6 m (15 ft) No. 134 jib butt and strut, stop

Length	4,67 m	15' 4"
Width	0,86 m	2' 10"
Height	1,29 m	4' 3"
Weight	635 kg	1,400 lb

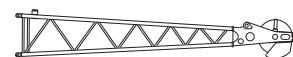

4,6 m (15 ft) No. 134 jib top and pendants

Length	4,93 m	16' 2"
Width	0,79 m	2' 7"
Height	0,79 m	2' 7"
Weight	553 kg	1,220 lb

Option

Outline dimensions

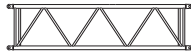

3,0 m (10 ft) No. 134 jib insert and pendants

Length	3,12 m	10 3
Width	0,79 m	27
Height	0,79 m	27
Weight	218 kg	480 lb

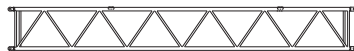

6,1 m (20 ft) No. 134 jib insert and pendants

Length	6,17 m	20 3
Width	0,79 m	27
Height	0,79 m	27
Weight	340 kg	750 lb

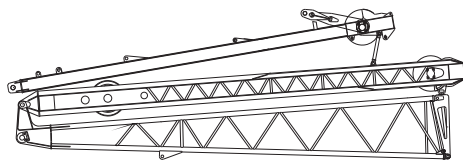

8,2 m (27 ft) No. 135 luffing jib butt and struts

Length	8,81 m	28 11
Width	1,57 m	52
Height	2,92 m	97
Weight	4 477 kg	9,870 lb

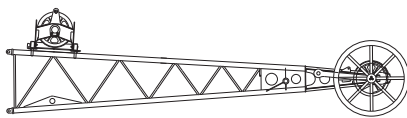

7,0 m (23 ft) No. 135 luffing jib top and roller, pendants

Length	7,80 m	25' 7
Width	1,52 m	5 0
Height	2,02 m	6 8
Weight	1 984 kg	4,375 lb

Note: Includes wire rope guide.

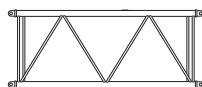

3,0 m (10 ft) No. 135 luffing jib insert and pendants

Length	3,15 m	10 4
Width	1,52 m	5' 0
Height	1,30 m	4' 3
Weight	381 kg	840 lb

 Option

Outline dimensions

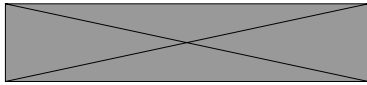

6,1 m (20 ft) No. 135 luffing jib insert and pendants

Length	6,20 m	20 4
Width	1,52 m	5 0
Height	1,30 m	4 3
Weight	612 kg	1,350 lb

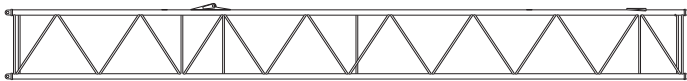

12,2 m (40 ft) No. 135 luffing jib insert and pendants

Length	12,29 m	40' 4"
Width	1,52 m	5' 0"
Height	1,30 m	4' 3"
Weight	1 050 kg	2,315 lb

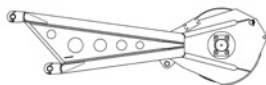

No. 76 upper boom point

Length	2,64 m	8' 8"
Width	0,41 m	1' 4"
Height	0,81 m	2' 8"
Weight	420 kg	925 lb

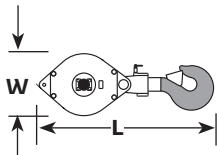

Hook block for 26 mm (1 inch) wire rope

Capacity	200 t	220 USt	Length	2,27 m	7' 5"
Weight	2 472 kg	5,450 lb	Width	0,84 m	2' 9"

Capacity	150 t	165 USt	Length	2,11 m	6' 11"
Weight	2 730 kg	6,000 lb	Width	0,90 m	2' 11"

Capacity	91 t	100 USt	Length	1,98 m	6' 6"
Weight	1 770 kg	3,900 lb	Width	0,88 m	2' 11"

Capacity	27 t	30 USt	Length	1,50 m	4' 11"
Weight	1 724 kg	3,801 lb	Width	0,71 m	2' 4"

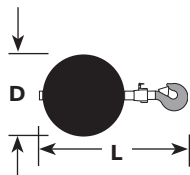

Weight ball

Capacity/Swivel	14 t	15 USt	Diameter	0,53 m	1' 9"
Weight	594 kg	1,310 lb	Length	1,13 m	3' 9"

Option

Transport data

Load summary													
Weight each item	No. 76 boom 65 m (213 ft) Series 2 Quantity on trailer load #												
Item	kg (lb)	1	2	3	4	5	6	7	8	9	10	11	12
Upperworks structure with carbody, gantry and mast	39 689 (87,500)	1											
Crawler assembly	17 690 (39,000)		1										
Crawler assembly	17 690 (39,000)			1									
9,0 m (29 ft 8 in) boom top	4 536 (10,000)				1								
5,5 m (18 ft 6 in) boom butt	2 858 (6,300)											1	
Upper side counterweight	7 938 (17,500)				1	2	2	2			1		
12,0 m (39 ft 5 in) boom insert	2 132 (4,700)					1	1	1		1			
5,5 m (18 ft 6 in) boom insert	1 633 (3,600)								1				
6,0 m (19 ft 8 in) boom insert	1 678 (3,700)								1				
3,0 m (10 ft 0 in) boom insert	771 (1,700)										1		
Counterweight tray	9 707 (21,400)								1				
Upper center counterweight	2,722 (6,000)									1			
Detachable upper boom point	499 (1,100)				1								
9,2 m (30 ft) #134 jib and strut	1,188 (2,620)		1										
3,0 m (10 ft) #134 jib insert	140 (310)			1									
6,1 m (20 ft) #134 jib insert	256 (565)			2									
Intermediate frame	680 (1,500)									1			
Lower carbody counterweight	12 111 (26,700)										1	1	
Load block - 91 t (100 USt)	1 814 (4,000)												1
14 t (15 USt) weight ball	2 604 (5,740)											1	
Rigging block and chain	600 (1,500)			1									
Miscellaneous	2 722 (6,000)												1
		39 689 (87,500)	18 878 (41,620)	19 023 (41,940)	12 972 (28,600)	18 008 (39,700)	8 008 (17,700)	8 008 (17,700)	13 018 (28,700)	5 533 (12,200)	20 820 (45,900)	17 572 (38,740)	6 668 (14,700)
		1	2	3	4	5	6	7	8	9	10	11	12

* NOTE: Does not include blocking, strapping etc.

Crane assembly

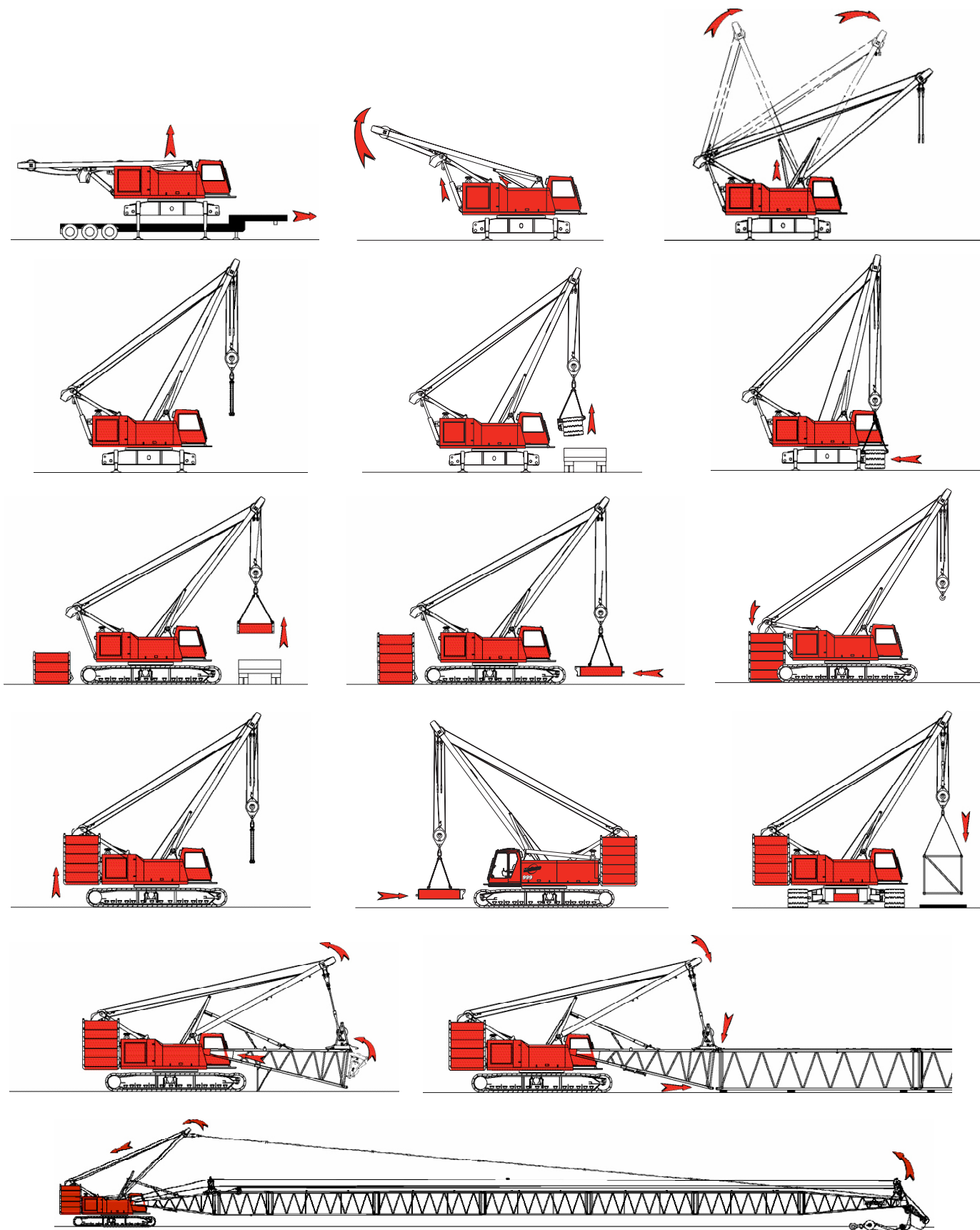

Note: Read the assembly folio in the operator's manual for a complete description of approved crane assembly procedures.

Performance data

Main and standard whip drum - 140 kN (31,500 lb)						
	Full power drum - continuous duty					
	Single line pull/single line speed					
	m/min (ft/min)					
Layer	1	2	3	4	5	6
Single line pull kg (lb)						
0 (0)	97 (318)	106 (347)	115 (377)	124 (406)	133 (435)	141 (464)
2 268 (5,000)	91 (299)	99 (324)	106 (349)	114 (374)	121 (399)	129 (423)
4 536 (10,000)	85 (279)	92 (301)	98 (322)	104 (340)	105 (344)	106 (347)
6 804 (15,000)	71 (232)	72 (236)	73 (240)	74 (243)	75 (247)	76 (250)
9 072 (20,000)	56 (184)	57 (188)	58 (191)	59 (195)	60 (198)	62 (202)
11 340 (25,000)	47 (155)	48 (158)	49 (162)	50 (166)	52 (169)	53 (173)
14 288 (31,500)	40 (131)	41 (134)	42 (138)	43 (142)	44 (145)	45 (149)

Luffing hoist drum / auxiliary drum - 89 kN (20,000 lb)								
	Full power drum - continuous duty							
	Single line pull/single line speed							
	m/min (ft/min)							
Layer	1	2	3	4	5	6	7	8
Single line pull kg (lb)								
0 (0)	85 (280)	92 (303)	99 (326)	106 (349)	113 (372)	120 (395)	127 (418)	134 (441)
2 268 (5,000)	79 (260)	85 (279)	91 (298)	97 (318)	103 (336)	108 (355)	114 (373)	119 (391)
4 536 (10,000)	73 (239)	78 (255)	79 (258)	80 (261)	81 (264)	82 (267)	82 (271)	83 (274)
6 804 (15,000)	55 (180)	56 (184)	57 (187)	58 (190)	59 (193)	60 (196)	61 (199)	62 (202)
9 072 (20,000)	44 (145)	45 (148)	46 (151)	47 (154)	48 (157)	49 (161)	50 (164)	51 (167)

Performance data

Wire rope lengths - single hoist line drum - 26 mm No. 76 main boom							
Boom or boom and jib length	Whip line - drum 1 or 3 (Front or auxiliary drum)				Hoist line - drum 2 (Rear drum)		Total parts of line
	1 Part		2 Part				
m (ft)	m	(ft)	m	(ft)	m	(ft)	
20 (66)	58	(190)	82	(270)	335	(1100)	14
23 (76)	64	(210)	91	(300)	366	(1200)	13
29 (95)	76	(250)	110	(360)	373	(1225)	11
35 (115)	88	(290)	128	(420)	411	(1350)	10
41 (135)	101	(330)	146	(480)	434	(1425)	9
47 (154)	113	(370)	165	(540)	450	(1475)	8
53 (174)	125	(410)	183	(600)	450	(1475)	7
59 (194)	137	(450)	201	(660)	450	(1475)	6
65 (213)	149	(490)	219	(720)	450	(1475)	5
71 (233)	162	(530)	238	(780)	450	(1475)	4
77 (253)	174	(570)	256	(840)	450	(1475)	4
83 (272)	186	(610)	274	(900)	450	(1475)	3
89 (292)	198	(650)	293	(960)	450	(1475)	3
95 (312)	210	(690)	311	(1020)	—	—	—
98 (322)	216	(710)	—	—	—	—	—

NOTE: Hoist and whip line lengths given in table will allow hook to touch ground. When block travel below ground is required, add additional rope equal to parts of line times added travel distance. Hoisting distance or line pull may be limited when block travel below ground is required.

Maximum wire rope length allowed on Drum 3 (Auxiliary Drum) is 235 m (770 ft).

Hoist reeving for main load block - 26 mm - No. 76 main boom		
No. Parts of Line	Maximum Load	
	kg	(lb)
1	14 290	31,500
2	28 580	63,000
3	42 860	94,500
4	57 150	126,000
5	71 440	157,500
6	85 730	189,000
7	100 020	220,500
8	114 310	252,000
9	128 590	283,500
10	142 880	315,000
11	157 170	346,500
12	171 460	378,000
13	185 750	409,500
14	200 030	441,000

Performance data

Wire rope lengths
Boom No. 76
 - or -
Fixed jib No. 134
Boom No. 76

Boom or boom and jib length	Whip line - drum 1 or 3 (front or auxiliary drum)				Hoist line - drum 2 (rear drum)		Total parts of line
	1 part		2 part				
	m	(ft)	m	(ft)	m	(ft)	
20 (66)	58	(190)	82	(270)	335	(1100)	14
23 (76)	64	(210)	91	(300)	366	(1200)	13
26 (85)	70	(230)	101	(330)	366	(1200)	12
29 (95)	76	(250)	110	(360)	373	(1225)	11
32 (105)	82	(270)	119	(390)	381	(1250)	10
35 (115)	88	(290)	128	(420)	411	(1350)	10
38 (125)	94	(310)	137	(450)	411	(1350)	9
41 (135)	101	(330)	146	(480)	434	(1425)	9
44 (144)	107	(350)	155	(510)	434	(1425)	8
47 (154)	113	(370)	165	(540)	450	(1475)	8
50 (164)	119	(390)	174	(570)	450	(1475)	7
53 (174)	125	(410)	183	(600)	450	(1475)	7
56 (184)	131	(430)	192	(630)	450	(1475)	6
59 (194)	137	(450)	201	(660)	450	(1475)	6
62 (203)	143	(470)	210	(690)	450	(1475)	5
65 (213)	149	(490)	219	(720)	450	(1475)	5
68 (223)	155	(510)	229	(750)	450	(1475)	5
71 (233)	162	(530)	238	(780)	450	(1475)	4
74 (243)	168	(550)	247	(810)	450	(1475)	4
77 (253)	174	(570)	256	(840)	450	(1475)	4
80 (263)	180	(590)	265	(870)	450	(1475)	3
83 (272)	186	(610)	274	(900)	450	(1475)	3
86 (282)	192	(630)	283	(930)	450	(1475)	3
89 (292)	198	(650)	293	(960)	450	(1475)	3
92 (302)	204	(670)	302	(990)	—	—	—
95 (312)	210	(690)	311	(1020)	—	—	—
98 (322)	216	(710)	—	—	—	—	—

NOTE: Hoist and whip line lengths given in table will allow hook to touch ground. When block travel below ground is required, add additional rope equal to parts of line times added travel distance. Hoisting distance or line pull may be limited when block travel below ground is required.

Maximum wire rope length allowed on Drum 3 (Auxiliary Drum) is 235 m (770 ft).

Performance data

Wire rope lengths Luffing jib No. 135 on Boom No. 76

Boom length*	Luffing jib hoist line		Maximum required parts of line
	Hoist line drum 2		
m (ft)	m (ft)	(ft)	
20 (66)	244	(800)	4
23 (76)	259	(850)	4
26 (85)	274	(900)	4
29 (95)	290	(950)	4
32 (105)	305	(1000)	4
35 (115)	320	(1050)	4
38 (125)	320	(1050)	3
41 (135)	335	(1100)	3
44 (144)	351	(1150)	3
47 (154)	351	(1150)	3
50 (164)	351	(1150)	3
53 (174)	366	(1200)	3
56 (184)	366	(1200)	3
59 (194)	366	(1200)	3

*Hoist line lengths given in table include all luffing jib lengths.

NOTE: Hoist line lengths given in table will allow hook to touch ground. When block travel below ground is required, add additional rope equal to parts of line times added travel distance. Hoisting distance or line pull may be limited when block travel below ground is required.

Drum capacities - wire rope

	Maximum length
	No lagging
Front or rear grooved drum 26 mm wire rope *	399 m (1,310 ft) 6 layers
Auxiliary drum (1") wire rope**	208 m (684 ft) 8 layers
Boom hoist drum 22,23 mm (7/8") wire rope	323 m (1,060 ft) 6 layers

*5,5 m (18 ft) is deducted from maximum spooling capacities for 3 dead wraps per drum on drums 1 and 2.

**6,1 m (20 ft) is deducted from maximum spooling capacity for 3 dead wraps on drum 3.

Wire rope specifications 5:1 Safety Factor Boom No. 76

- or -

Fixed jib No. 134 on boom No. 76

	5:1 Safety Factor Rotation resistant, 2160 N/mm ² Wire rope with Pad Eye		5:1 Safety Factor Rotation resistant, 2160 N/mm ² Wire rope with Pad Eye
	Hoist line	Whip line	Auxiliary line
Function	Hoist line	Whip line	Auxiliary line
Part number	No. 719432	No. 719432	No. 719436
Size wire rope	26 mm —	26 mm —	— (1")
Minimum breaking strength	71 940 kN (158,600 lb)	71 940 kN (158,600 lb)	69 760 kN (153,800 lb)
Maximum load per line	14 290 kg (31,500 lb)	14 290 kg (31,500 lb)	9 070 kN (20,000 lb)
Approximate weight	3,56 kg/m (2.39 lb/ft)	3,56 kg/m (2.39 lb/ft)	3,36 kg/m (2.26 lb/ft)

Performance data

Maximum length - unassisted raising

		No. 134 fixed jib on No. 76 main boom Series 2	
		Main boom	Fixed jib
Over end of blocked crawlers	m	*89,0	—
	(ft)	(292)	—
		86,0	—
		(282)	—
		83,0	—
		(272)	—
		80,0	12,2
	(262)	(40)	
	77,0	21,3	
	(253)	(70)	
	74,0	24,4	
	(242)	(80)	

NOTE: Load block(s), hook(s) and weight ball(s) on ground at start.

*Upper boom point cannot be used on 89,0 m (292 ft) boom or over side of crawlers on 80,0 m (262 ft) boom.

Maximum length - unassisted raising

		No. 134 fixed jib on No. 76 main boom Series 2	
		Main boom	Fixed jib
Over side of crawlers	m	*80,0	—
	(ft)	(262)	—
		77,0	—
		(253)	—
		74,0	9,1
		(243)	(30)
		71,0	18,3
		(233)	(60)
		68,0	21,3
	(223)	(70)	
	65,0	24,4	
	(213)	(80)	

NOTE: Load block(s), hook(s) and weight ball(s) on ground at start.

*Upper boom point cannot be used on 89,0 m (292 ft) boom or over side of crawlers on 80,0 m (262 ft) boom.

Maximum length - unassisted raising

		No. 135 luffing jib on No. 76 main boom Series 2			
		In-line method No. 135 luffing jib		Jack-knife method No. 135 luffing jib	
Boom length	Over end of blocked crawlers	Over side of crawlers	Over end of blocked crawlers	Over side of crawlers	
m (ft)					
20,0 (66)	21,3 - 51,8 (70 - 170)	21,3 - 51,8 (70 - 170)	—	—	
23,0 (76)	21,3 - 51,8 (70 - 170)	21,3 - 51,8 (70 - 170)	—	—	
26,0 (85)	21,3 - 51,8 (70 - 170)	21,3 - 51,8 (70 - 170)	—	—	
29,0 (95)	21,3 - 51,8 (70 - 170)	21,3 - 51,8 (70 - 170)	—	—	
32,0 (105)	21,3 - 51,8 (70 - 170)	21,3 - 51,8 (70 - 170)	—	—	
35,0 (115)	21,3 - 51,8 (70 - 170)	21,3 - 48,8 (70 - 160)	—	51,8 (170)	
38,0 (125)	21,3 - 51,8 (70 - 170)	21,3 - 39,6 (70 - 130)	—	42,7 - 51,8 (140 - 170)	
41,0 (134)	21,3 - 45,7 (70 - 150)	21,3 - 33,5 (70 - 110)	48,8 - 51,8 (160 - 170)	36,6 - 51,8 (120 - 170)	
44,0 (144)	21,3 - 42,7 (70 - 140)	21,3 - 27,4 (70 - 90)	45,7 - 51,8 (150 - 170)	30,5 - 51,8 (100 - 170)	
47,0 (154)	21,3 - 33,5 (70 - 110)	—	36,6 - 51,8 (120 - 170)	21,3 - 51,8 (70 - 170)	
50,0 (164)	21,3 - 27,4 (70 - 90)	—	30,0 - 51,8 (100 - 170)	21,3 - 51,8 (70 - 170)	
53,0 (174)	—	—	21,3 - 51,8 (70 - 170)	—	
56,0 (184)	—	—	21,3 - 51,8 (70 - 170)	—	
59,0# (194)	—	—	21,3 - 51,8 (70 - 170)	—	

NOTE: Load block(s), hook(s) and weight ball(s) on ground until boom and luffing jib are erected. Boom lengths shown with a pound sign (#) require lower boom point and wire rope guide assembly No. 177364 to be removed.

Boom combinations

No. 76 main boom with heavy-lift top combinations				
Boom length m (ft)	Boom inserts m (ft)			
	3,0 (9.8)	6,0 (9.7)	12,0 (39.4)	12,0* (39.4)
20 (65.6)	0	0	0	0
23 (75.5)	1	0	0	0
26 (85.3)	0	1	0	0
29 (95.1)	1	1	0	0
32 (105.0)	0	0	0	1
35 (114.8)	1	0	0	1
38 (124.7)	0	1	0	1
41 (134.5)	1	1	0	1
44 (144.4)	0	0	1	1
47 (154.2)	1	0	1	1
50 (164.0)	0	1	1	1
53 (173.9)	1	1	1	1
56 (183.7)	0	0	2	1
59 (193.6)	1	0	2	1
62 (203.4)	0	1	2	1
65 (213.3)	1	1	2	1
68 (223.1)	0	0	3	1
71 (233.0)	1	0	3	1
74 (242.8)	0	1	3	1
77 (252.6)	1	1	3	1
80 (262.5)	0	0	4	1
83 (272.3)	1	0	4	1
86 (282.2)	0	1	4	1
89 (292.0)	1	1	4	1

* with backstay assembly.

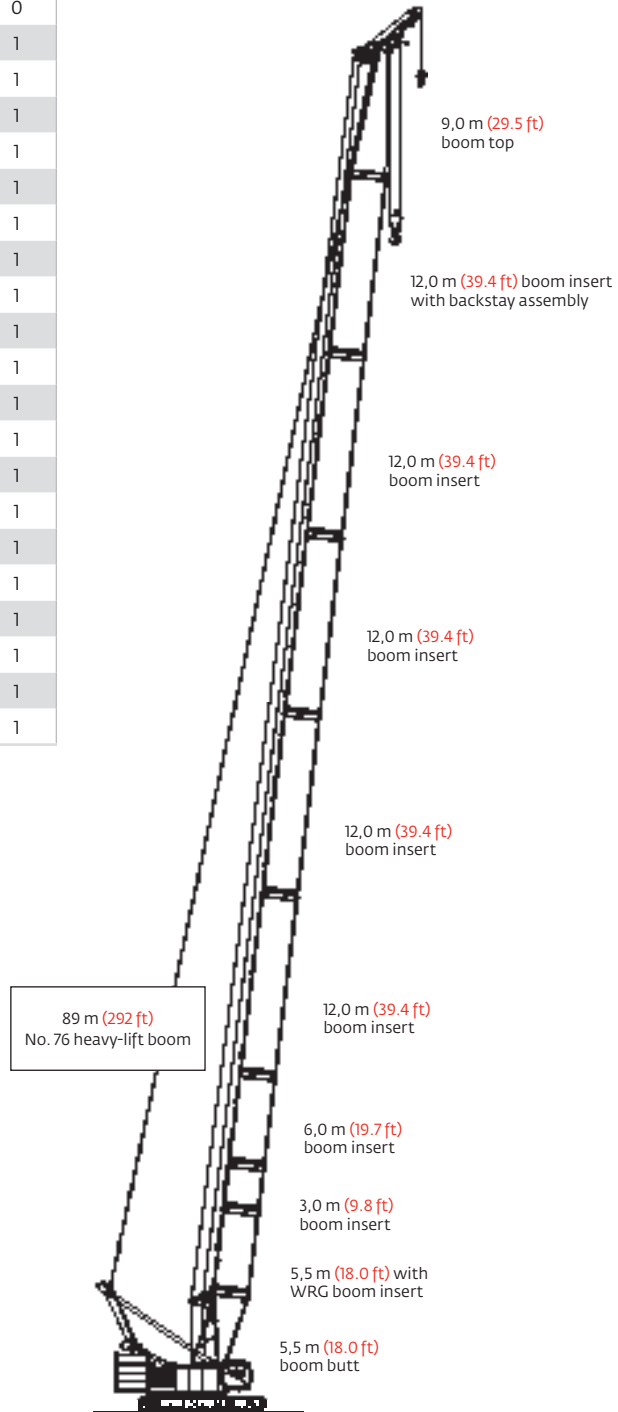

Boom combinations

No. 134 fixed jib combinations		
Fixed jib length m (ft)	Fixed jib inserts m (ft)	
	3,05 (10.0)	6,10 (20.0)
9,14 (30)	0	0
12,19 (40)	1	0
15,27 (50)	0	1
18,29 (60)	1	1
21,33 (70)	0	2
24,38 (80)	1	2

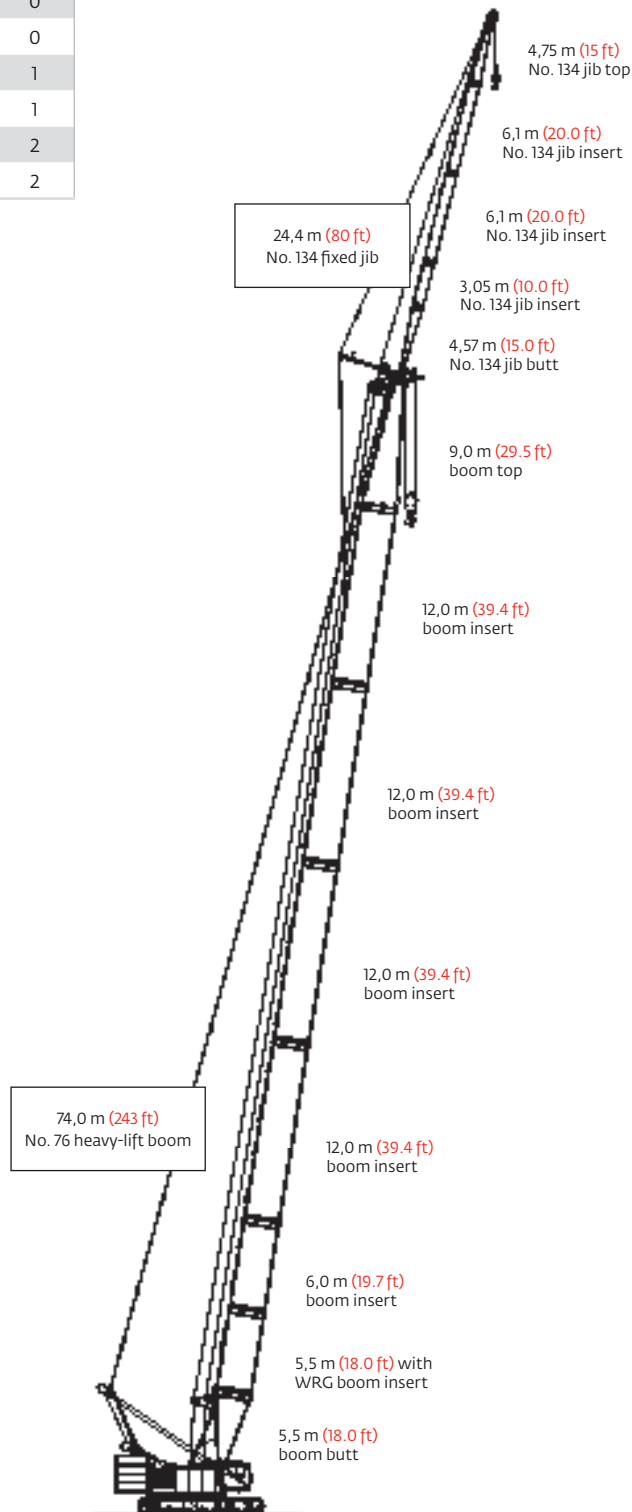

Boom combinations

No. 135 luffing jib combinations

Luffing jib length m (ft)	Luffing jib inserts		
	3,05 (10.0)	6,10 (20.0)	12,19 (40.C)
21,3 (70)	0	1	0
24,4 (80)	1	1	0
27,4 (90)	0	0	0
30,5 (100)	1	0	0
33,5 (110)	0	1	0
36,6 (120)	1	1	0
39,6 (130)	0	0	1
42,7 (140)	1	0	1
45,7 (150)	0	1	1
48,8 (160)	1	1	1
51,8 (170)	0	0	2

* with backstay lug.

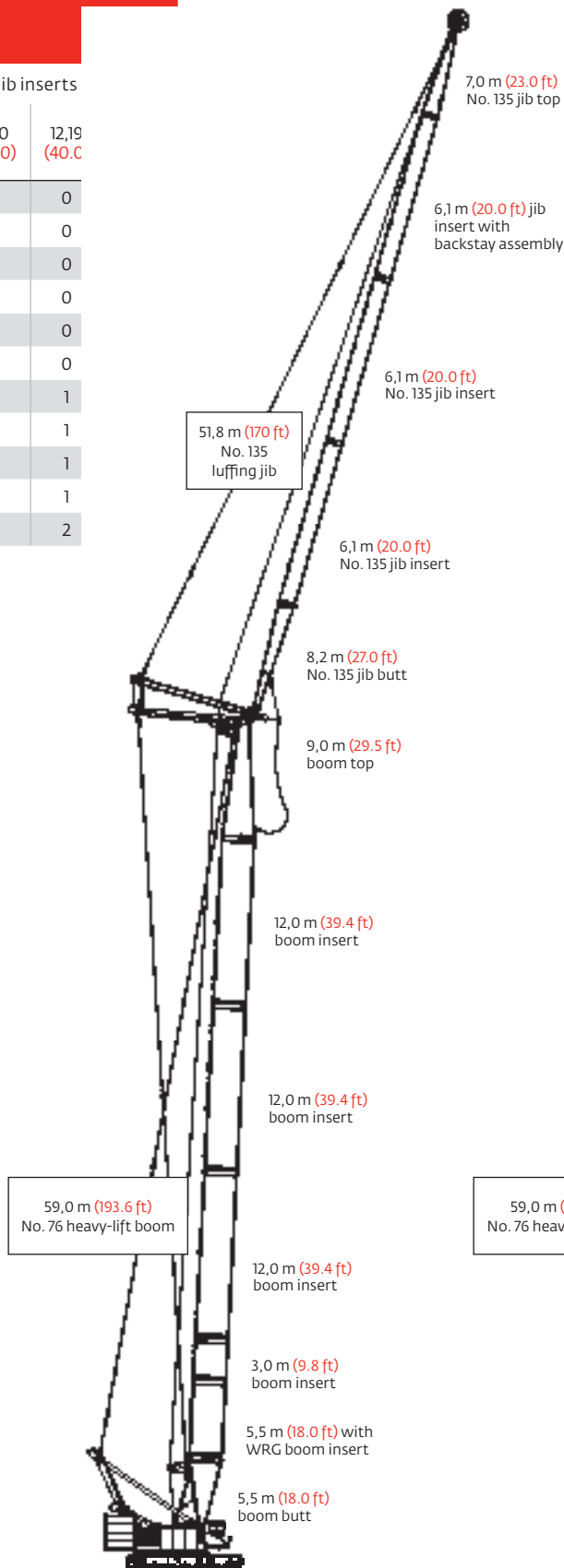

No. 138 fixed jib combinations

Fixed jib length m (ft)	Fixed jib inserts m (ft)
	3,05 (10.0)
9,1 (30)	0
12,2 (40)	1
15,2 (50)	2
18,3 (60)	3

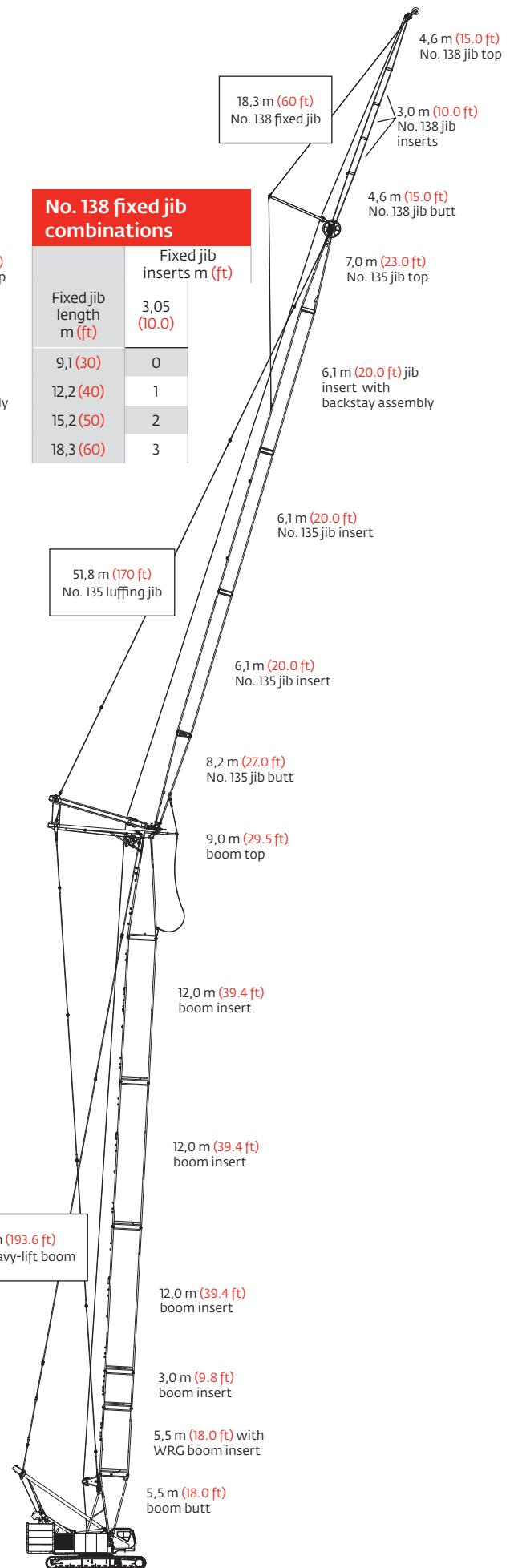

Heavy-lift boom range diagram

No. 76 heavy-lift main boom

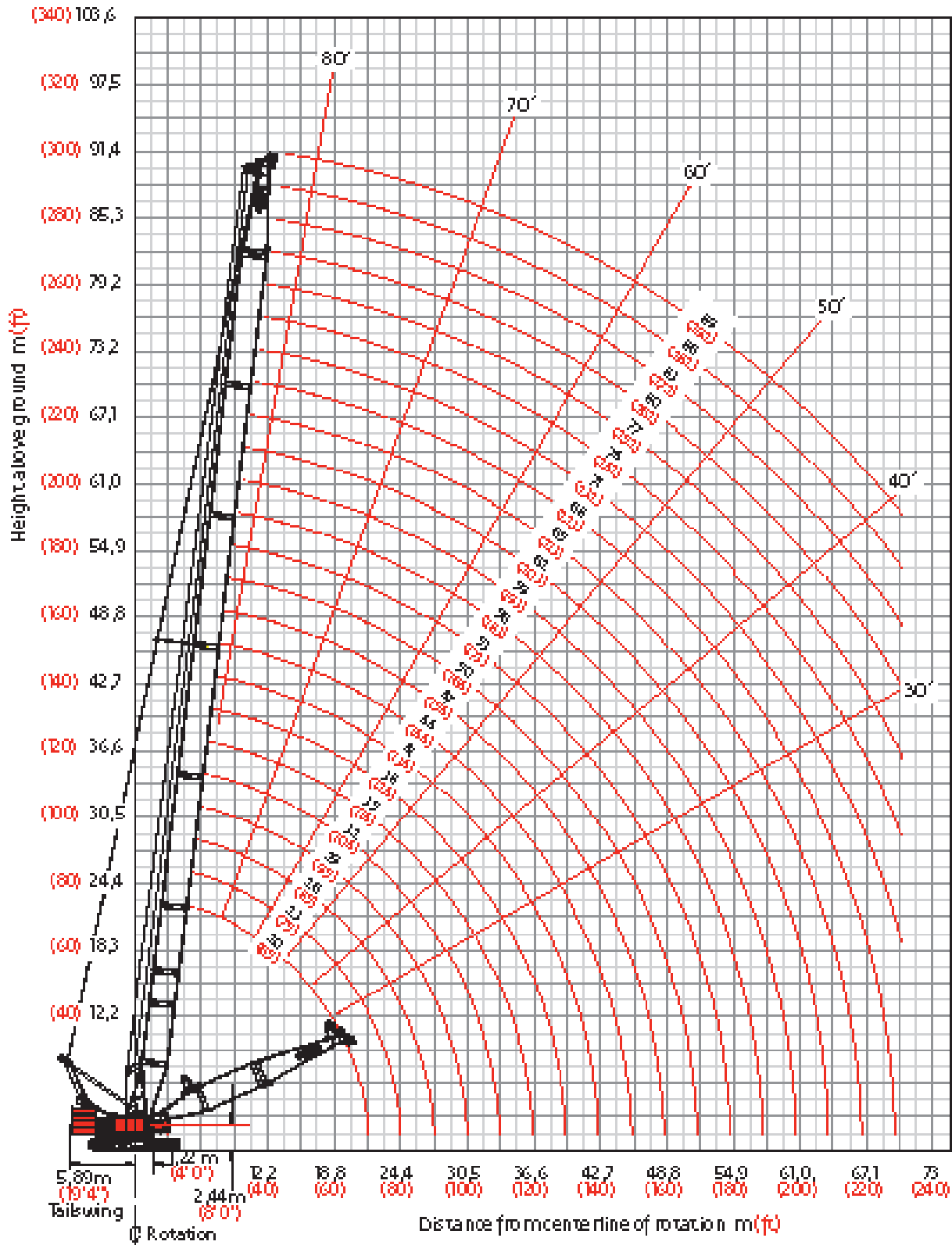

Heavy-lift boom load charts

No. 76 heavy-lift main boom

76 200 kg (168,000 lb) counterweight 24 040 kg (53,000 lb) Carbody counterweight

360° Rating

kg (lb) x 1 000

Boom m (ft)	20,0 (66)	26,0 (85)	32,0 (105)	38,0 (125)	44,0 (144)	50,0 (164)	56,0 (184)	62,0 (203)	68,0 (223)	74,0 (243)	80,0 (263)	86,0 (282)	89,0 (292)
Radius													
4,3 (14)	200,0 (441.0)												
8,0 (26)	109,3 (243.4)	109,0 (242.4)	108,7 (242.1)	108,5 (241.6)	104,7 (195.7)								
10,0 (32)	87,1 (198.0)	87,0 (197.5)	86,8 (196.9)	86,7 (196.5)	86,4 (144.5)	86,5 (195.0)	77,9 (173.4)	67,9 (150.4)					
12,0 (40)	67,0 (144.6)	67,1 (144.8)	67,1 (144.8)	67,1 (144.8)	67,0 (118.4)	66,9 (144.2)	66,8 (143.8)	65,4 (143.4)	58,8 (129.4)	50,2 (110.6)			
14,0 (46)	53,9 (118.8)	54,0 (119.0)	54,0 (118.9)	53,9 (118.8)	53,8 (81.7)	53,6 (118.0)	53,4 (117.6)	53,2 (117.2)	52,9 (116.5)	49,4 (109.0)	40,6 (89.5)	35,2 (77.6)	32,4 (71.5)
18,0 (60)	38,0 (82.2)	38,1 (82.4)	38,1 (82.3)	38,0 (82.2)	37,8 (65.8)	37,6 (81.3)	37,4 (80.7)	37,1 (80.2)	36,8 (79.4)	36,8 (79.5)	36,7 (78.9)	34,1 (75.0)	31,3 (69.0)
22,0 (70)		28,9 (66.6)	28,8 (66.5)	28,8 (66.4)	28,5 (49.9)	28,3 (65.4)	28,1 (64.8)	27,8 (64.3)	27,4 (63.4)	27,5 (63.5)	27,1 (62.8)	26,8 (62.1)	26,7 (61.8)
26,0 (85)			22,8 (50.6)	22,7 (50.4)	22,5 (39.2)	22,3 (49.5)	22,0 (48.8)	21,7 (48.2)	21,3 (47.4)	21,3 (47.4)	21,0 (46.7)	20,7 (46.0)	20,5 (45.6)
30,0 (100)			18,4 (39.8)	18,4 (39.7)	18,2 (33.8)	18,0 (38.8)	17,7 (38.1)	17,4 (37.5)	17,0 (36.6)	17,0 (36.6)	16,7 (35.9)	16,4 (35.2)	16,2 (34.8)
34,0 (110)				15,2 (34.3)	14,9 (29.4)	14,8 (33.4)	14,4 (32.7)	14,2 (32.2)	13,8 (31.3)	13,8 (31.2)	13,4 (30.5)	13,1 (29.8)	12,9 (29.4)
38,0 (120)					12,5 (25.7)	12,3 (29.0)	12,0 (28.3)	11,7 (27.7)	11,3 (26.8)	11,3 (26.8)	10,9 (26.0)	10,6 (25.3)	10,4 (24.9)
40,0 (130)					11,4 (22.5)	11,2 (25.3)	10,9 (24.6)	10,7 (24.1)	10,3 (23.2)	10,2 (23.1)	9,9 (22.3)	9,6 (21.6)	9,4 (21.2)
44,0 (140)						9,5 (22.2)	9,1 (21.5)	8,9 (20.9)	8,5 (20.0)	8,5 (20.0)	8,1 (19.2)	7,8 (18.5)	7,6 (18.1)
48,0 (155)						7,9 (18.2)	7,7 (17.6)	7,4 (17.0)	7,0 (16.1)	7,0 (16.1)	6,6 (15.3)	6,3 (14.6)	6,1 (14.2)
52,0 (170)							6,4 (14.4)	6,2 (13.8)	5,7 (12.9)	5,7 (12.9)	5,4 (12.1)	5,1 (11.4)	4,9 (11.0)
56,0 (180)								5,1 (12.0)	4,7 (11.1)	4,7 (11.1)	4,3 (10.3)	4,0 (9.6)	3,8 (9.2)
60,0 (195)								4,2 (9.6)	3,8 (8.7)	3,8 (8.7)	3,4 (7.9)	3,1 (7.2)	2,9 (6.8)
64,0 (210)									3,0 (6.7)	3,0 (6.7)	2,6 (5.9)	2,3 (5.2)	2,1 (4.8)
68,0 (220)										2,3 (5.5)	1,9 (4.7)		
70,0 (230)										2,0 (4.4)			

For complete chart, refer to www.cranelibrary.com.

Fixed jib range diagram

No. 134 fixed jib on No. 76 main boom

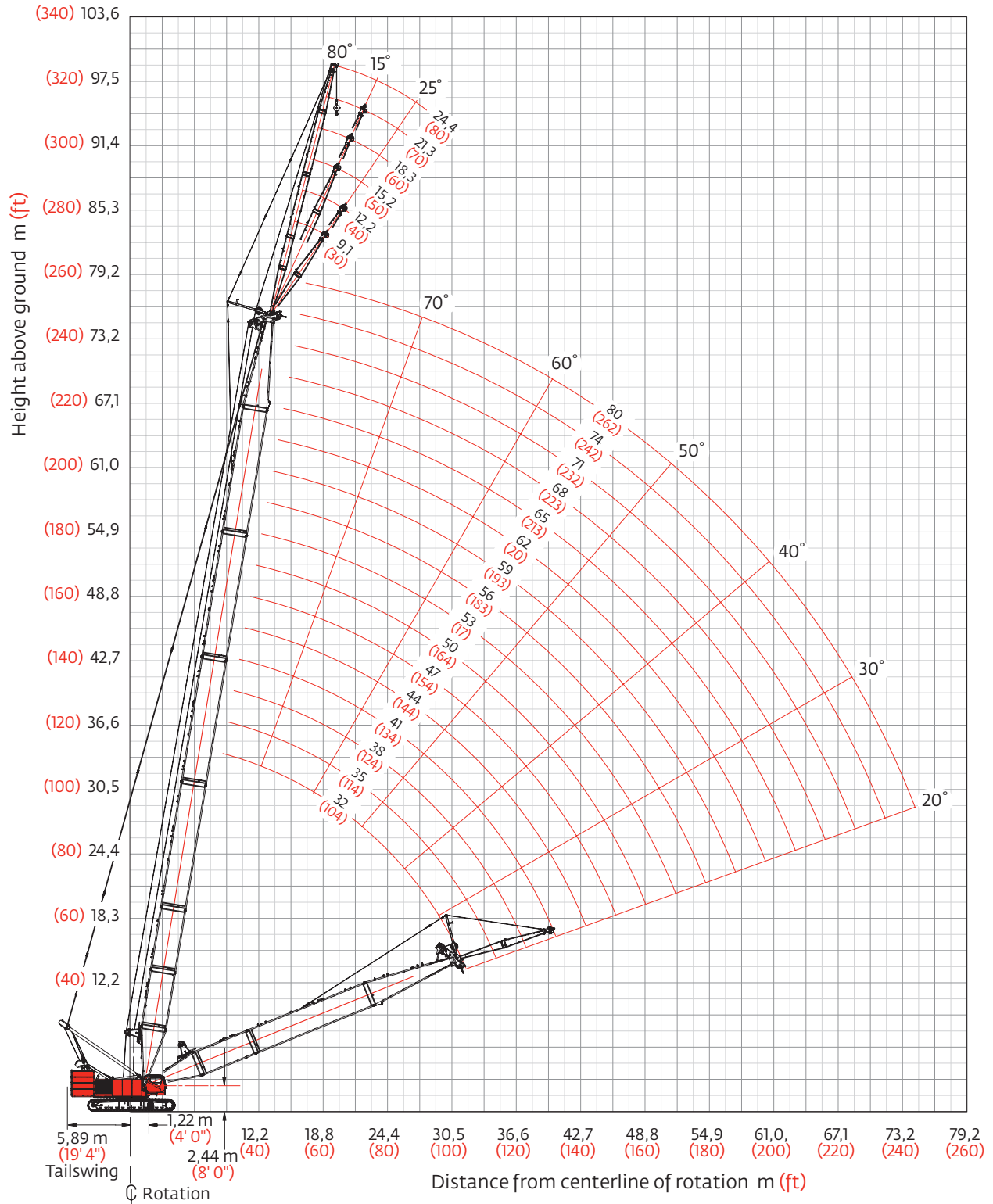

Fixed jib load charts

No. 134 fixed jib on No. 76 main boom

76 200 kg (168,000 lb) counterweight
360° Rating

24 000 kg (53,000 lb) carbody counterweight
kg (lb) x 1 000

		5° offset					25° offset				
Boom m (ft)		32,0 (105.0)	44,0 (144.4)	56,0 (183.7)	68,0 (223.1)	80,0 (262.5)	32,0 (105.0)	44,0 (144.4)	56,0 (183.7)	68,0 (223.1)	80,0 (262.5)
9,1 m (30.0 ft) jib length	Radius										
	9,1 (30)	28,5 (63.0)									
	12,0 (40)	28,5 (63.0)	28,5 (63.0)	— (63.0)							
	16,0 (50)	27,2 (60.6)	27,9 (62.1)	27,9 (62.0)	27,2 (60.5)		19,9 (45.1)	21,6 (48.6)			
	22,0 (70)	25,2 (56.1)	26,2 (58.2)	26,4 (58.7)	26,0 (57.7)	24,8 (55.5)	17,0 (38.3)	18,8 (42.1)	20,1 (45.0)	21,2 (47.3)	22,0 (49.1)
	28,0 (90)	21,0 (47.8)	20,4 (46.4)	19,7 (45.0)	19,0 (43.4)	18,5 (42.4)	15,0 (33.6)	16,8 (37.4)	18,2 (40.5)	19,2 (43.0)	19,7 (44.6)
	36,0 (120)	14,5 (31.3)	13,9 (30.0)	13,2 (28.5)	12,5 (26.8)	12,0 (25.7)		14,3 (30.8)	13,7 (29.5)	13,1 (28.1)	12,6 (27.2)
	48,0 (150)		8,4 (20.4)	7,7 (18.9)	7,0 (17.2)	6,5 (16.2)			8,0 (19.6)	7,3 (18.1)	6,9 (17.2)
	56,0 (180)			5,4 (12.7)	4,7 (11.0)	4,2 (9.9)				4,9 (11.6)	4,5 (10.7)
	64,0 (210)				29,0 (6.6)	2,5 (5.6)					2,7 (6.1)
	70,0 (235)				1,9 (4.3)						
	76,0 (255)										

		5° offset				25° offset			
Boom m (ft)		32,0 (105.0)	44,0 (144.4)	56,0 (183.7)	68,0 (223.1)	32,0 (105.0)	44,0 (144.4)	56,0 (183.7)	68,0 (223.1)
15,2 m (50.0 ft) jib length	Radius								
	9,1 (30)								
	12,0 (40)	20,1 (44.2)	— (44.7)						
	16,0 (50)	18,8 (42.1)	19,3 (43.0)	19,3 (42.9)					
	22,0 (70)	17,2 (38.5)	18,0 (40.0)	18,2 (40.4)	18,0 (39.9)	12,3 (27.7)	13,3 (30.0)	14,2 (31.8)	14,8 (33.2)
	28,0 (90)	15,8 (35.1)	16,8 (37.4)	17,2 (38.3)	17,2 (38.1)	10,6 (23.8)	11,7 (26.2)	12,6 (28.2)	13,3 (29.7)
	36,0 (120)	13,4 (29.2)	14,4 (30.9)	13,6 (29.4)	12,9 (27.7)	9,1 (20.0)	10,1 (22.3)	11,0 (24.2)	11,8 (25.9)
	48,0 (150)	— (22.8)	8,8 (21.4)	8,1 (19.8)	7,3 (18.1)		— (19.7)	8,6 (21.0)	8,0 (19.6)
	56,0 (180)		6,5 (15.1)	5,8 (13.5)	5,0 (11.8)			6,1 (14.3)	5,5 (12.9)
	64,0 (210)			4,1 (9.1)	3,3 (7.4)				3,6 (8.1)
	70,0 (235)				2,3 (4.5)				
	76,0 (255)								

For complete chart, refer to www.cranelibrary.com.

Fixed jib load charts

No. 134 fixed jib on No. 76 main boom

76 200 kg (168,000 lb) counterweight
360° Rating

24 000 kg (53,000 lb) carbody counterweight
kg (lb) x1 000

		5° offset				25° offset			
Boom m (ft)		32,0 (105.0)	44,0 (144.4)	56,0 (183.7)	68,0 (223.1)	32,0 (105.0)	44,0 (144.4)	56,0 (183.7)	68,0 (223.1)
18,3 m (60.0 ft) jib length	Radius								
	9,1 (30)								
	12,0 (40)	17,2 (38.0)							
	16,0 (50)	16,1 (36.2)	16,5 (36.8)	16,5 (36.7)					
	22,0 (70)	14,5 (32.5)	15,3 (34.1)	15,5 (34.5)	15,3 (34.1)	11,1 (25.0)	12,0 (27.0)	12,6 (28.3)	
	28,0 (90)	13,2 (29.5)	14,1 (31.4)	14,6 (32.4)	14,6 (32.5)	9,4 (21.2)	10,4 (23.3)	11,1 (24.9)	11,8 (26.3)
	36,0 (120)	11,7 (25.4)	12,8 (28.1)	13,4 (29.5)	13,1 (27.9)	7,9 (17.4)	8,9 (19.4)	9,6 (21.1)	10,3 (22.6)
	48,0 (150)	8,6 (20.1)	9,0 (21.7)	8,2 (20.1)	7,4 (18.3)		7,4 (16.9)	8,1 (18.5)	8,3 (19.9)
	56,0 (180)		6,7 (15.4)	5,9 (13.8)	5,1 (12.0)			6,4 (14.9)	5,8 (13.5)
	64,0 (210)			4,2 (9.4)	3,4 (7.6)				3,9 (8.7)
	70,0 (235)			3,1 (7.0)	2,4 (5.3)				
	76,0 (255)								

		5° offset				25° offset			
Boom m (ft)		32,0 (105.0)	44,0 (144.4)	56,0 (183.7)	68,0 (223.1)	32,0 (105.0)	44,0 (144.4)	56,0 (183.7)	68,0 (223.1)
24,4 m (80.0 ft) jib length	Radius								
	9,1 (30)								
	12,0 (40)	— (23.4)							
	16,0 (50)	10,2 (22.7)	10,1 (22.6)	9,9 (22.0)					
	22,0 (70)	9,4 (21.1)	9,5 (21.3)	9,5 (21.2)	9,3 (20.7)	8,9 (19.8)			
	28,0 (90)	8,8 (19.6)	8,9 (19.9)	9,0 (20.0)	8,9 (19.8)	7,5 (16.9)	8,2 (18.5)	8,6 (19.2)	8,7 (19.3)
	36,0 (120)	8,1 (17.8)	8,2 (18.2)	8,4 (18.4)	8,3 (18.4)	6,1 (13.5)	6,8 (15.0)	7,4 (16.3)	7,9 (17.4)
	48,0 (150)	6,8 (15.5)	7,4 (16.8)	7,5 (17.0)	7,5 (17.1)	4,9 (11.2)	5,5 (12.7)	6,1 (14.0)	6,6 (15.1)
	56,0 (180)	— (13.3)	6,8 (15.4)	6,1 (14.2)	5,3 (12.4)		4,9 (11.1)	5,4 (12.3)	5,9 (13.3)
	64,0 (210)		5,2 (11.5)	4,4 (9.8)	3,6 (8.0)			4,9 (10.9)	4,2 (9.4)
	70,0 (235)			3,4 (7.5)	2,6 (5.7)				3,1 (6.3)
	76,0 (255)			2,5 (5.6)					2,1 (4.2)

For complete chart, refer to www.cranelibrary.com.

Luffing jib range diagram

No. 135 luffing jib on No. 76 main boom

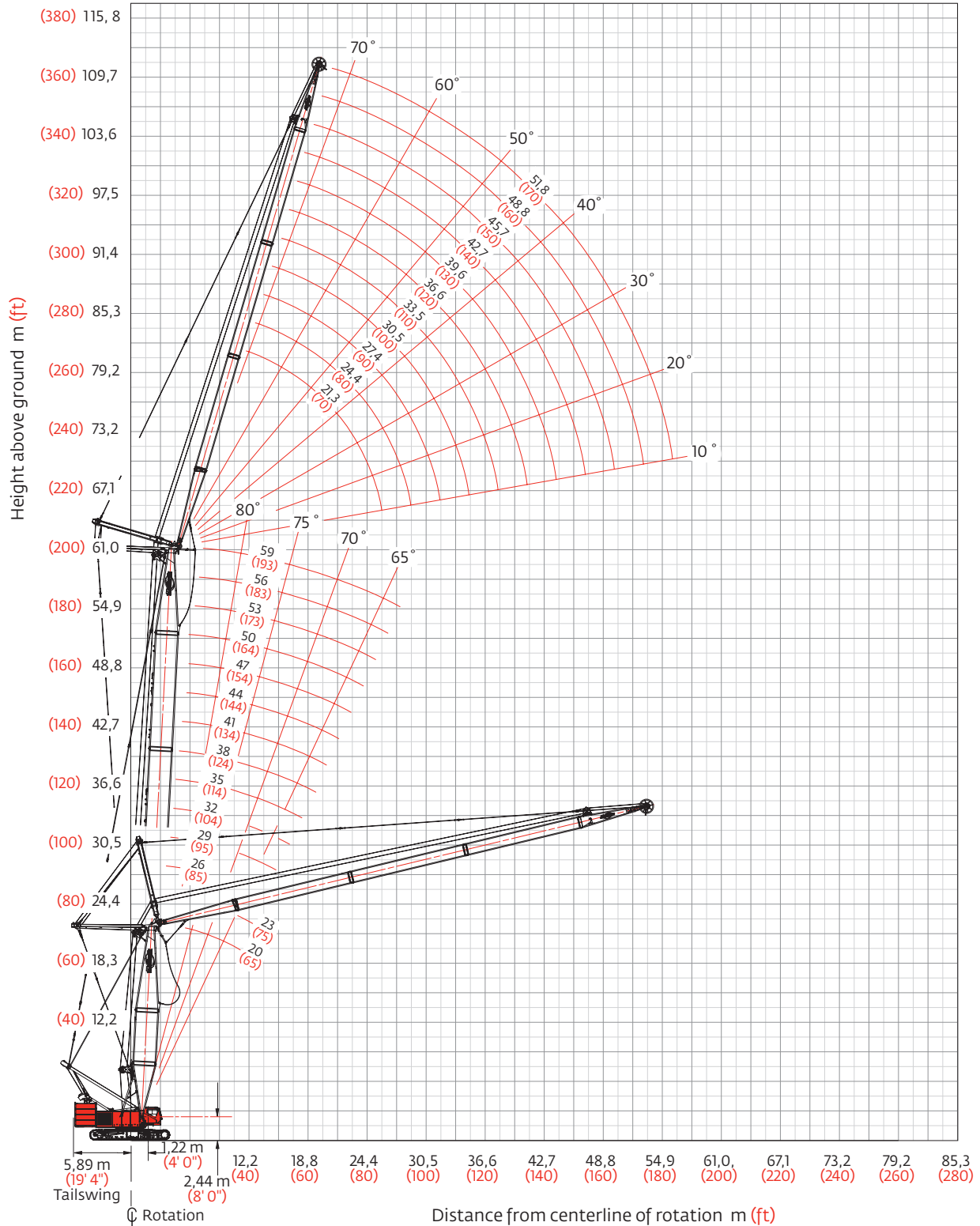

Luffing jib load charts

No. 135 luffing jib on No. 76 heavy-lift main boom

76 200 kg (168,000 lb) counterweight
360° Rating

24 000 kg (53,000 lb) carbody counterweight
kg (lb) x 1 000

87° boom angle

	Boom	20,0	32,0	44,0	53,0	59,0		Boom	20,0	32,0	44,0	53,0	59,0
	m (ft)	(65.6)	(105.0)	(144.4)	(173.9)	(193.6)		m (ft)	(65.6)	(105.0)	(144.4)	(173.9)	(193.6)
21,3 m (70 ft) Luffing jib length	Radius							Radius					
	8,5 (28)	53,7 (118.6)						8,5 (28)					
	10,0 (34)	51,7 (112.4)	48,6 (107.3)	43,0 (94.9)	— (85.0)			10,0 (34)					
	12,0 (40)	48,0 (105.3)	48,1 (105.6)	43,0 (94.9)	38,4 (84.8)	35,6 (78.5)		12,0 (40)	36,7 (80.6)	36,3 (80.0)			
	16,0 (50)	42,4 (95.7)	42,7 (96.3)	37,6 (86.2)	34,9 (79.6)	31,6 (72.1)		16,0 (50)	32,2 (72.8)	32,2 (72.8)	31,9 (71.6)	29,8 (65.9)	22,9 (51.1)
	20,0 (65)	33,8 (75.5)	36,0 (80.4)	31,4 (69.8)	29,3 (65.2)	26,7 (59.5)		20,0 (65)	28,5 (63.2)	28,6 (63.6)	28,6 (63.4)	27,2 (60.5)	21,8 (48.2)
	24,0 (80)		25,6 (52.2)	26,4 (57.2)	24,9 (54.2)	22,8 (49.6)		24,0 (80)	25,4 (55.6)	25,7 (56.3)	25,1 (54.7)	23,6 (51.4)	20,7 (45.6)
	26,0 (85)				— (44.9)	— (46.8)		26,0 (85)	23,9 (53.0)	24,5 (54.3)	23,4 (51.9)	22,0 (48.8)	19,6 (43.5)
	28,0 (95)							28,0 (95)	21,5 (45.4)	23,0 (48.3)	21,8 (46.8)	20,6 (44.1)	18,4 (39.5)
	32,0 (105)							32,0 (105)	16,6 (36.7)	19,1 (42.2)	19,2 (42.4)	18,1 (40.0)	16,2 (35.9)
	34,0 (115)							34,0 (115)				16,6 (31.7)	15,2 (32.6)

	Boom	20,0	32,0	44,0	53,0	59,0		Boom	20,0	32,0	44,0	53,0	59,0
	m (ft)	(65.6)	(105.0)	(144.4)	(173.9)	(193.6)		m (ft)	(65.6)	(105.0)	(144.4)	(173.9)	(193.6)
42,7 m (140 ft) Luffing jib length	Radius							Radius					
	15,2 (50)	21,9 (48.5)	21,1 (46.7)					15,2 (50)					
	20,0 (65)	20,0 (44.4)	19,9 (44.2)	19,1 (42.2)	18,8 (40.2)	17,3 (38.2)		20,0 (65)	15,6 (34.7)	15,6 (34.6)	15,3 (34.0)	14,1 (31.3)	13,6 (30.2)
	24,0 (80)	17,8 (38.8)	17,9 (39.1)	17,9 (39.1)	17,5 (38.5)	16,8 (37.0)		24,0 (80)	13,7 (30.0)	13,8 (30.1)	13,8 (30.1)	12,8 (28.0)	12,6 (27.7)
	28,0 (95)	15,8 (34.0)	16,0 (34.5)	16,1 (34.7)	16,0 (34.6)	15,9 (34.3)		28,0 (95)	12,0 (25.6)	12,2 (26.1)	12,2 (26.3)	11,5 (24.7)	11,4 (24.6)
	34,0 (115)	13,3 (28.7)	13,6 (29.2)	13,8 (29.7)	13,9 (29.9)	13,8 (29.8)		34,0 (115)	9,7 (20.8)	10,0 (21.3)	10,1 (21.6)	9,6 (20.5)	9,6 (20.6)
	40,0 (130)	11,4 (25.4)	11,6 (26.0)	11,8 (26.4)	12,0 (26.7)	12,0 (26.8)		40,0 (130)	7,9 (17.7)	8,1 (18.1)	8,3 (18.6)	7,9 (17.7)	8,0 (17.9)
	44,0 (145)	9,7 (21.0)	10,6 (23.4)	10,8 (23.9)	10,9 (24.1)	10,8 (23.9)		44,0 (145)	6,8 (15.0)	7,0 (15.4)	7,2 (15.8)	6,9 (15.2)	6,9 (15.3)
	48,0 (160)							48,0 (160)	5,8 (12.5)	6,0 (12.9)	6,2 (13.4)	6,0 (13.0)	6,1 (13.2)
	52,0 (175)							52,0 (175)	4,8 (10.1)	5,0 (10.4)	5,2 (10.8)	5,0 (10.5)	5,1 (10.7)
	56,0 (185)							56,0 (185)				4,1 (9.1)	4,2 (9.3)

For complete chart, refer to www.cranelibrary.com.

Luffing jib load charts

No. 135 luffing jib on No. 76 heavy-lift main boom

76 200 kg (168,000 lb) counterweight
360° rating

24 000 kg (53,000 lb) carbody counterweight
kg (lb) x 1 000

75° boom angle

	Boom	20,0	32,0	44,0	53,0	59,0		Boom	20,0	32,0	44,0	53,0	59,0
	m (ft)	(65.6)	(105.0)	(144.4)	(173.9)	(193.6)		m (ft)	(65.6)	(105.0)	(144.4)	(173.9)	(193.6)
21,3 m (70 ft) Luffing jib length	Radius							Radius					
	18,0	40,0						18,0					
	(55)	(96.5)						(55)					
	20,0	35,0						20,0					
	(65)	(78.2)						(65)					
	24,0	27,9	26,5					24,0	27,6	—			
	(80)	(60.4)	(57.5)					(80)	(59.7)	(56.6)			
	28,0		21,9	20,5	19,3	18,5		28,0	22,8	21,5	20,1		
	(95)		(46.4)	(43.5)	(40.9)	—		(95)	(48.2)	(45.6)	(42.5)		
	32,0			17,3	16,3	15,6		32,0	19,2	18,2	17,0	15,8	15,1
	(105)			(38.3)	(36.1)	(34.4)		(105)	(42.5)	(40.2)	(37.5)	(35.0)	(33.3)
	34,0				15,1	14,4		34,0	17,8	16,8	15,7	14,7	13,9
(115)				(32.1)	(30.6)		(115)	(37.8)	(35.8)	(33.3)	(31.2)	(29.6)	
38,0					12,4		38,0		14,6	13,6	12,7	12,0	
(125)					(27.3)		(125)		(32.1)	(29.9)	(27.9)	(26.5)	
42,0							42,0			11,9	11,1	10,5	
(135)							(135)			(27.0)	(25.2)	(23.9)	
44,0							44,0				10,4	9,8	
(145)							(145)				(22.8)	(21.7)	
46,0							46,0					9,2	
(155)							(155)					(19.6)	

	Boom	20,0	32,0	44,0	53,0	59,0		Boom	20,0	32,0	44,0	53,0	59,0
	m (ft)	(65.6)	(105.0)	(144.4)	(173.9)	(193.6)		m (ft)	(65.6)	(105.0)	(144.4)	(173.9)	(193.6)
42,7 m (140 ft) Luffing jib length	Radius							Radius					
	28,0	17,8						28,0					
	(90)	(40.0)						(90)					
	34,0	15,1	16,3	15,2	—			34,0	11,2	—			
	(115)	(32.4)	(34.9)	(32.3)	(30.0)			(115)	(24.0)	(26.4)			
	38,0	13,5	14,2	13,1	12,2	11,5		38,0	9,8	10,9	—		
	(125)	(29.8)	(31.3)	(28.9)	(26.8)	(25.4)		(125)	(21.6)	(24.0)	(26.1)		
	44,0	11,5	11,7	10,8	9,9	9,4		44,0	7,9	8,9	9,9	9,6	9,0
	(145)	(25.4)	(25.7)	(23.7)	(21.9)	(20.6)		(145)	(17.5)	(19.6)	(21.7)	(21.2)	(19.9)
	46,0	11,0	11,0	10,1	9,3	8,8		46,0	7,4	8,3	9,3	9,0	8,4
	(155)	(23.7)	(23.4)	(21.6)	(19.9)	(18.8)		(155)	(15.7)	(17.6)	(19.7)	(19.2)	(18.0)
	50,0		9,7	9,0	8,3	7,8		50,0	6,4	7,2	8,1	8,0	7,5
(165)		(21.4)	(19.7)	(18.2)	(17.1)		(165)	(14.1)	(15.8)	(17.8)	(17.5)	(16.4)	
54,0			8,0	7,4	6,9		54,0	5,4	6,2	7,1	7,1	6,6	
(180)			(17.3)	(15.9)	(15.0)		(180)	(11.5)	(13.3)	(15.2)	(15.3)	(14.3)	
60,0					—		60,0		4,7	5,5	5,9	5,6	
(195)					(13.1)		(195)		(10.8)	(12.6)	(13.4)	(12.6)	
64,0							64,0			4,5	4,9	4,9	
(210)							(210)			(10.1)	(10.8)	(11.0)	
68,0							68,0					4,3	
(225)							(225)					(9.4)	

For complete chart, refer to www.cranelibrary.com.

Luffing jib load charts

No. 135 luffing jib on No. 76 heavy-lift main boom

76 200 kg (168,000 lb) counterweight
360° rating

24 000 kg (53,000 lb) carbody counterweight
kg (lb) x 1 000

65° boom angle

		20,0	32,0	44,0	53,0	59,0			20,0	32,0	44,0	53,0	59,0		
		m (ft)	(65.6)	(105.0)	(144.4)	(173.9)	(193.6)			m (ft)	(65.6)	(105.0)	(144.4)	(173.9)	(193.6)
21,3 m (70 ft) Luffing jib length	Radius														
	26,0	23,8													
	(80)	(57.0)													
	28,0	21,7													
	(95)	(46.0)	—												
	32,0		16,7												
	(105)		(36.9)												
	34,0		15,4	13,5											
	(115)		(32.8)	(28.7)											
	38,0			11,7	—										
	(125)			(25.8)	(22.5)										
42,0				8,9	7,9										
(135)				(20.2)	(18.1)										
44,0				8,3	7,4										
(145)				(18.2)	(16.3)										
46,0					6,9										
(155)					(14.7)										
52,0															
(170)															
56,0															
(185)															
30,5 m (100 ft) Luffing jib length	Radius														
	26,0														
	(80)														
	28,0														
	(95)														
	32,0														
	(105)														
	34,0														
	(115)														
	38,0														
	(125)														
42,0															
(135)															
44,0															
(145)															
46,0															
(155)															
52,0															
(170)															
56,0															
(185)															

		20,0	32,0	44,0	53,0			20,0	32,0	44,0		
		m (ft)	(65.6)	(105.0)	(144.4)	(173.9)			m (ft)	(65.6)	(105.0)	(144.4)
42,7 m (140 ft) Luffing jib length	Radius											
	38,0	14,1										
	(120)	(32.7)										
	42,0	12,3	10,9									
	(135)	(28.0)	(24.8)									
	44,0	11,5	10,2									
	(145)	(25.4)	(22.5)									
	46,0	10,9	9,6	—								
	(155)	(23.2)	(20.4)	(17.2)								
	52,0	—	8,0	6,7	5,5							
	(170)	(20.3)	(17.9)	(15.0)	(12.4)							
56,0		7,2	6,0	4,9								
(185)		(15.7)	(13.1)	(10.7)								
60,0			5,3	4,3								
(200)			(11.4)	(9.3)								
66,0												
(215)												
68,0												
(225)												
70,0												
(235)												
51,8 m (170 ft) Luffing jib length	Radius											
	38,0											
	(120)											
	42,0											
	(135)											
	44,0	8,9										
	(145)	(19.5)										
	46,0	8,3	—									
	(155)	(17.6)	(19.7)									
	52,0	6,7	7,7	6,4								
	(170)	(14.9)	(17.2)	(14.2)								
56,0	5,7	6,9	5,6									
(185)	(12.5)	(15.1)	(12.3)									
60,0	4,7	6,1	5,0									
(200)	(10.1)	(12.8)	(10.8)									
66,0		4,5	4,2									
(215)		(10.3)	(9.4)									
68,0			3,9									
(225)			(8.6)									
70,0			3,7									
(235)			(7.8)									

For complete chart, refer to www.cranelibrary.com.

Manitowoc Crane Care

Manitowoc Crane Care is the industry's most advanced service and support program, designed to keep your cranes up and running. Manitowoc's distributor network and customer support personnel are available to support you 24 hours a day, 7 days a week, 365 days a year. There are five key disciplines of Manitowoc Crane Care:

Parts

Genuine Manitowoc replacement parts are accessible through your distributor.

Service and technical support

Assistance with crane selection, lift planning and ground bearing calculations or field service and maintenance.

Technical publications

Operator, parts, service and capacity chart manuals are available in multiple formats in major languages.

Training

A variety of training courses are available online or through Manitowoc training centers.

EnCORE

Rebuild, repair, remanufacture or exchange your current crane through our local network, for a fraction of the cost of a new crane.

www.manitowoccranecare.com

CraneSTAR

CraneSTAR is an exclusive and innovative crane asset management system that helps improve your profitability and reduce costs by remotely monitoring critical crane data. Visit www.cranestar.com for more information.

Notes

Manitowoc Cranes

Regional headquarters

Americas

Manitowoc, Wisconsin, USA

Tel: +1 920 684 6621

Fax: +1 920 683 6277

Shady Grove, Pennsylvania, USA

Tel: +1 717 597 8121

Fax: +1 717 597 4062

Europe, Middle East, Africa

Ecully, France

Tel: +33 (0)4 72 18 20 20

Fax: +33 (0)4 72 18 20 00

China

Shanghai, China

Tel: +86 21 6457 0066

Fax: +86 21 6457 4955

Greater Asia-Pacific

Singapore

Tel: +65 6264 1188

Fax: +65 6862 4040

Regional offices

Americas

Brazil

Alphaville

Mexico

Monterrey

Chile

Santiago

Europe, Middle East,

Africa

Czech Republic

Netvorice

France

Baudemont

Cergy

Decines

Germany

Langenfeld

Hungary

Budapest

Italy

Lainate

Netherlands

Breda

Poland

Warsaw

Portugal

Baltar

Russia

Moscow

South Africa

Johannesburg

U.A.E.

Dubai

U.K.

Buckingham

China

Beijing

Chengdu

Guangzhou

Xian

Greater Asia-Pacific

Australia

Brisbane

Melbourne

Sydney

India

Chennai

Delhi

Hyderabad

Pune

Korea

Seoul

Philippines

Makati City

Singapore

Factories

Brazil

Passo Fundo

China

TaiAn

Zhangjiagang

France

Charlieu

Moulins

Germany

Wilhelmshaven

India

Pune

Italy

Niella Tanaro

Portugal

Baltar

Fânzeres

Slovakia

Saris

USA

Manitowoc

Port Washington

Shady Grove

This document is non-contractual. Constant improvement and engineering progress make it necessary that we reserve the right to make specification, equipment, and price changes without notice. Illustrations shown may include optional equipment and accessories and may not include all standard equipment.