



# TFC-280-45

# CRANE SPECIFICATIONS



## BOOM

Angle lattice alloy steel construction, with pin joints. Open throat with four boom point sheaves on anti-friction-bearings of bottom diameter 610 mm.  
10 part boom hoist reeving standard for all boom lengths.

Maximum Rated Load ..... 75,000 kg  
at 3.67 m operating radius

Basic Boom Length ..... 15.24 m  
(in two sections)

Boom Upper .. 9.14 m (30 ft)  
Boom Lower .. 6.10 m (20 ft)

Operating Weight ..... 70,480 kg  
[Equipped with 75 tonne capacity hook and 21.6 tonne counter weight]

Boom Inserts ..... 3 m (10 ft) Optional  
6 m (20 ft) Optional

### Hook Block

75 tonne 4 sheave with swivel hook and 8 part hoist line ..... Standard

Weight of Hook Block Assembly with 4 sheave ..... 998 kg

This hook block assembly can be converted to 3 sheave or 2 sheave or single sheave by using required spacers.

### Hoist Reeving and Hook Block Assembly

No. of Sheaves	4	3	2	1	
No. of parts of line	8	6	4	2	1
Maximum Load kg	75,000	68,040	45,360	22,680	11,340
Hook Block Weight kg	*998	*946	721	669	

\* Note: Use 171.5 kg cheek plate

## Drum Shaft Assembly

Lifting Crane Drums Pitch dia (mm)	Cable dia (mm)	Cable Capacity 1st wrap (m)	Line* Pulls (kg)	Line* Speeds (mpm)
FRONT 635	26	39.32	15730	49
REAR 635	26	22.25	16787	49

\*Line pulls and speeds based on first layer of rope and engine at full load speed

## Ground Pressure

	STANDARD	OPTIONAL
Shoe width	914 mm.	1067 mm.
Ground Pressure	0.73 kg/sq.cm.	0.64 kg/sq.cm.



## JIB

Angle lattice alloy steel construction, Two jib lengths are available.

..... 6.10 m (20 ft)  
..... 9.14 m (30 ft)  
Jib Hook Block Weight ..... 300 kg  
Capacity ... 7000 kg

## MAXIMUM JIB RATINGS

Offset angle jib to boom under full load	6.10 m jib	9.14 m jib
	kg	kg
5°	6350	5895
10°	6125	5670
15° (max.)	5895	5445

Jib ratings at any operating radius are the same as Crane ratings shown in table for main boom when operated at that radius but not to exceed maximum jib ratings shown. Maximum jib operating radius not to exceed length of main boom on which it is being used.

## RATED CRANE LOADS IN KG (AS PER IS 4573)

Operating radius	15.24m boom	18.29m boom	21.34m boom	24.38m boom	27.43m boom	30.48m boom	33.53m boom	36.58m boom	39.62m boom	42.67m boom	45.72m boom
3.67	75000	.....	.....	.....	.....	.....	.....	.....	.....	.....	.....
4.57	52165	51960	.....	.....	.....	.....	.....	.....	.....	.....	.....
6.10	32660	32455	32320	32115	31980	.....	.....	.....	.....	.....	.....
7.62	24040	23835	23700	23495	23360	23155	23020	.....	.....	.....	.....
9.14	19005	18800	18665	18460	18325	18120	17985	17780	.....	.....	.....
10.67	15600	15400	15260	15060	14920	14720	14580	14380	14240	14040	.....
12.19	13155	12950	12815	12610	12475	12270	12130	11930	11790	11590	11450
13.72	11340	11135	11000	10795	10660	10455	10320	10115	9980	9775	9640
15.24	9885	9685	9545	9345	9205	9005	8865	8660	8525	8320	8185
16.76	.....	8595	8460	8255	8120	7915	7780	7575	7440	7235	7095
18.29	.....	7685	7550	7345	7210	7005	6870	6665	6530	6325	6190
19.81	.....	.....	6735	6530	6395	6190	6055	5850	5715	5510	5375
21.34	.....	.....	6055	5850	5715	5510	5375	5170	5035	4830	4695
24.38	.....	.....	.....	4850	4715	4510	4375	4170	4035	3830	3695
27.43	.....	.....	.....	.....	3900	3695	3560	3355	3220	3015	2880
30.48	.....	.....	.....	.....	.....	3060	2925	2720	2585	2480	2245
33.53	.....	.....	.....	.....	.....	.....	.....	2220	2085	1880	1745
36.58	.....	.....	.....	.....	.....	.....	.....	.....	.....	1425	1290

## CRANE RANGE DIAGRAM

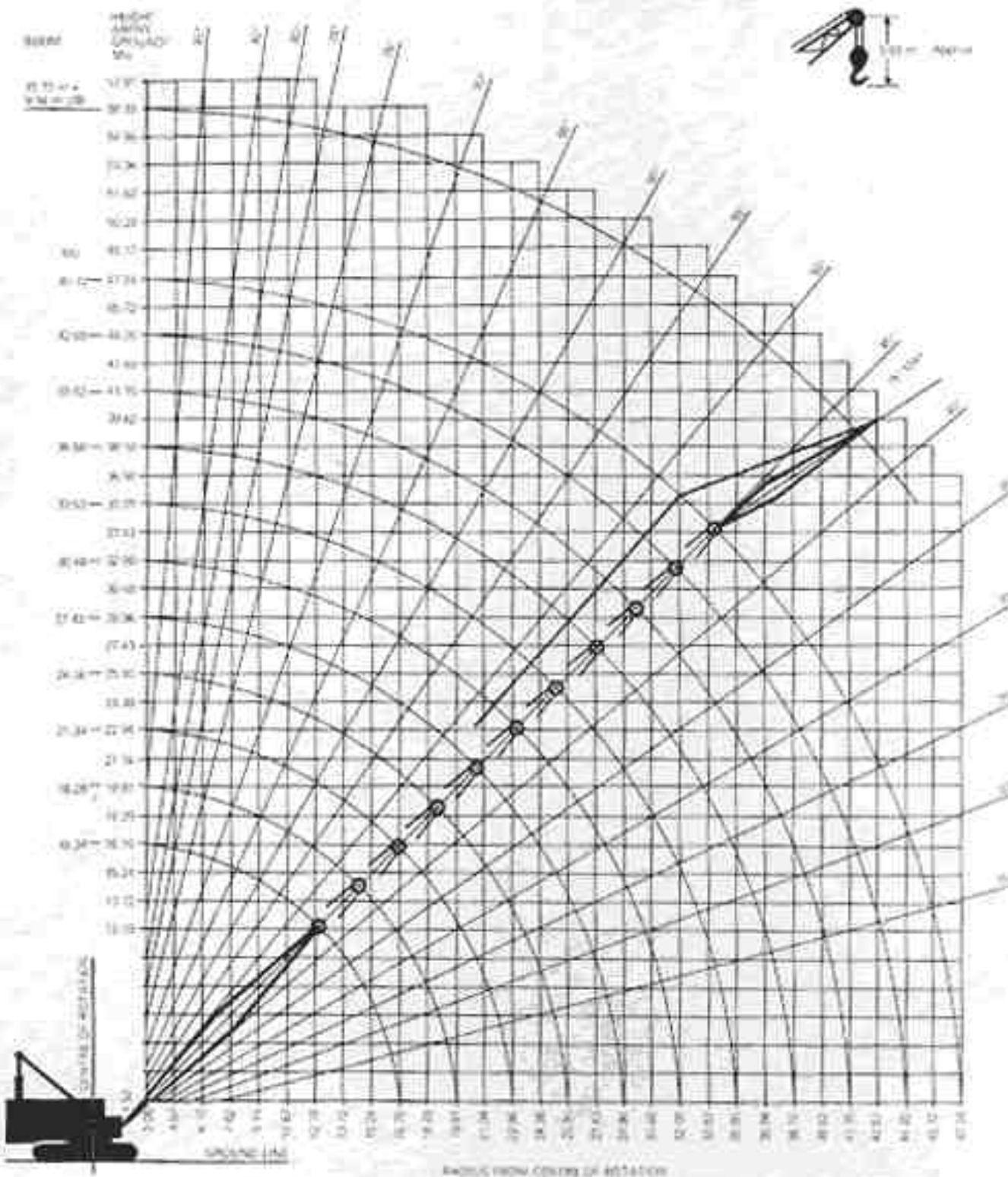







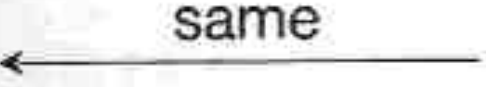
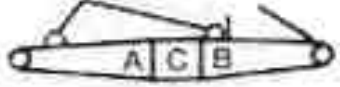
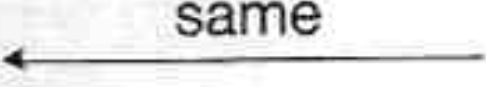

### NOTE

- (a) Ratings are as per IS 4573, ie, 75% of tipping load for forward stability and 70% for backward stability.
- (b) Capacities include the weight of the hook block, slings, etc.
- (c) Capacities are for machine standing on firm, level uniform supporting surface and depend upon the mounting, Ground, boom length, radius of operation and proper handling; all of which must be taken into account by the user.
- (d) Deduct 680 kg for 6.10m jib and 910 kg for 9.14m jib.

### CAUTION

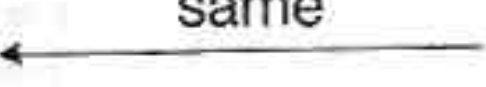
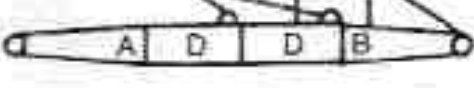
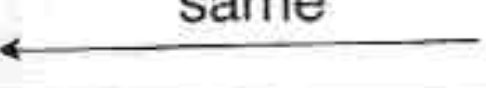
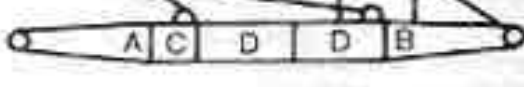
Machine must not be used for lifting operations with the gantry in lowered position.

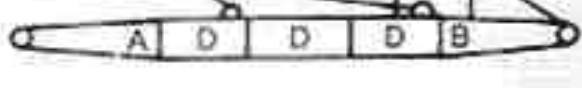
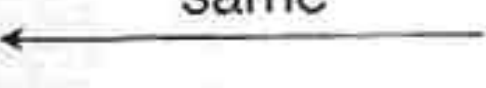
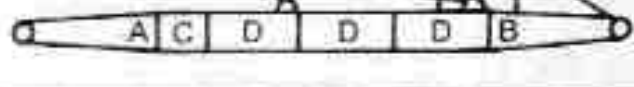
# Main Boom Construction

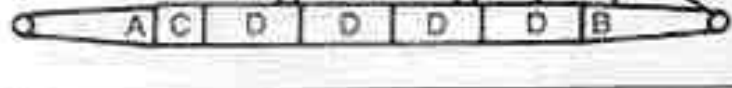
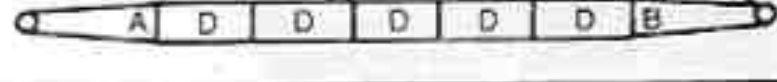
Boom Length	Boom Construction Crane	Boom Construction Clamshell & Dragline
50'		
60'		
70'		
80'		
90'		
100'		
110'		
120'		
130'		
140'		
150'		

- A = Lower Boom (20')
- B = Upper Boom (30')
- C = Boom Insert 10'
- D = Boom Insert 20'

# TRANSPORTATION DATA

## Basic Machine

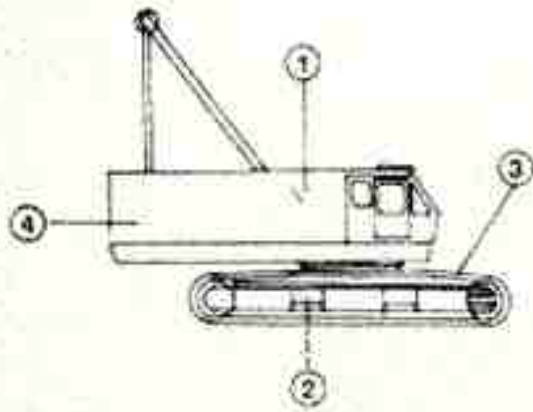

①: Superstructure (with gantry); 21,600 kg.

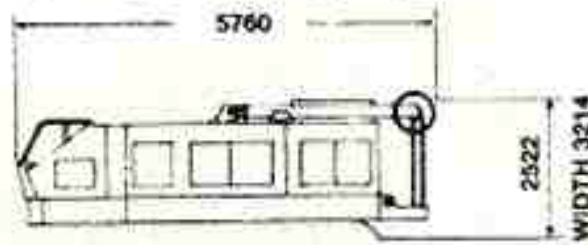

③ Side frames; 8,900 kg. x 2

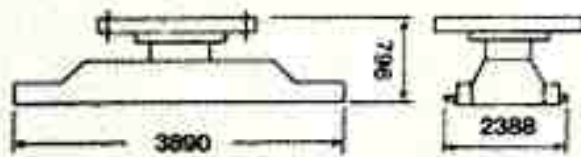
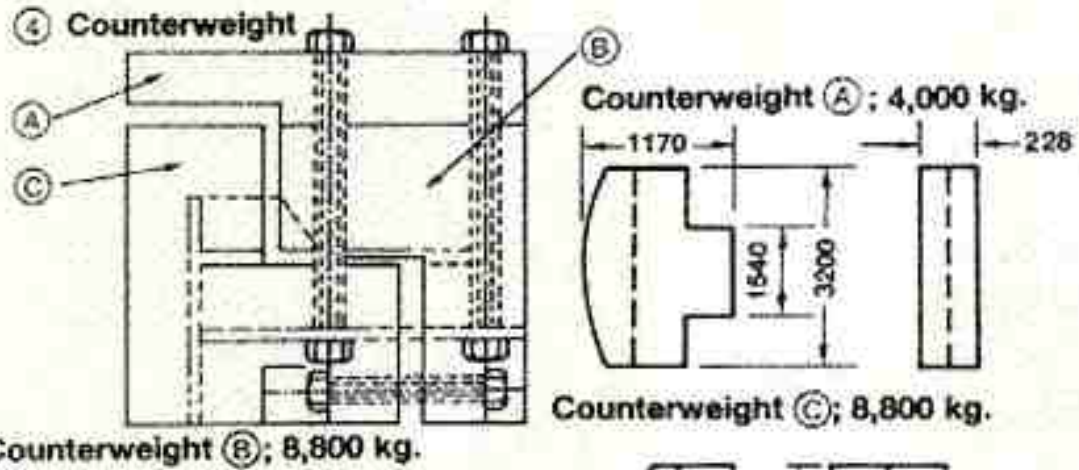
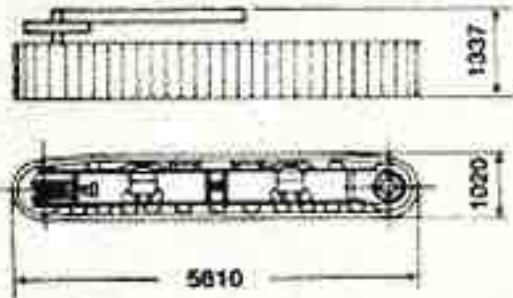

Counterweight (B); 8,800 kg.

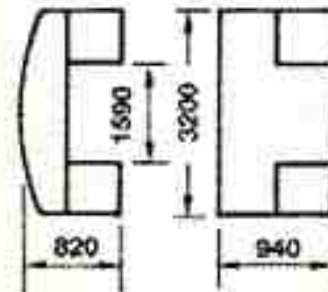
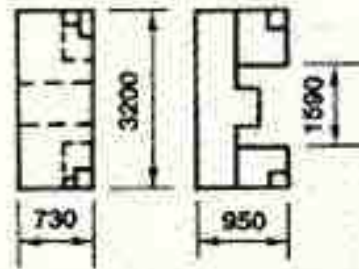

Note: All dimensions in mm

## Crane Attachment

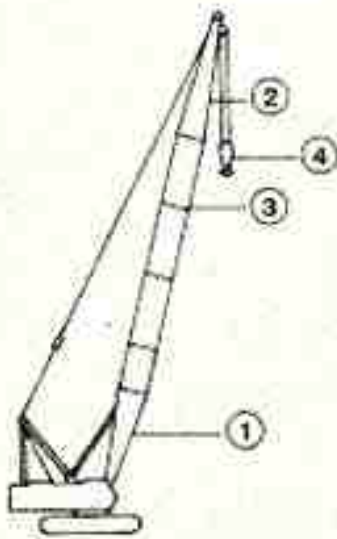

① Lower boom; 20 ft.  
2,300 kg.

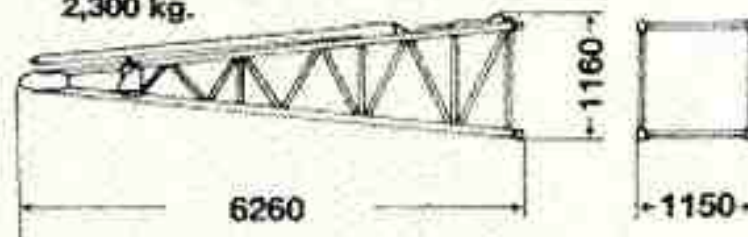

④ 75-tonne hook block;  
998 kg.

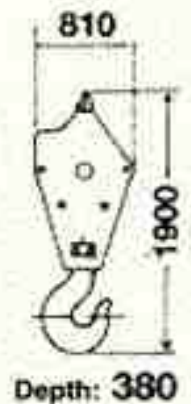

② Upper boom; 30 ft.  
2,280 kg.

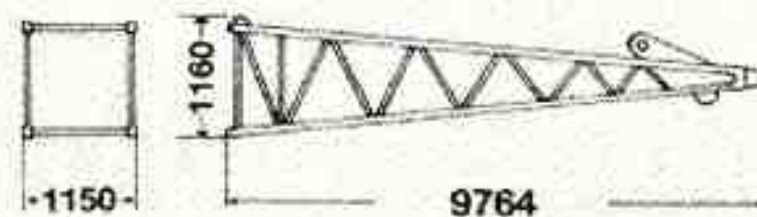

④-2 20 ft. boom insert;  
734 kg.

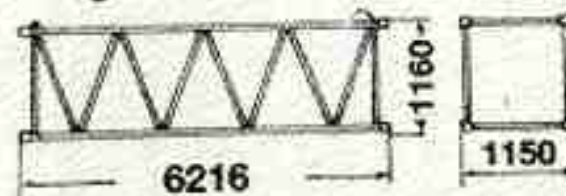

④-1 10 ft. boom insert;  
411 kg.

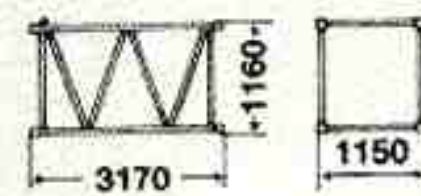

Note: All dimensions in mm

# TFC - 280 - 45

## BASIC SPECIFICATIONS

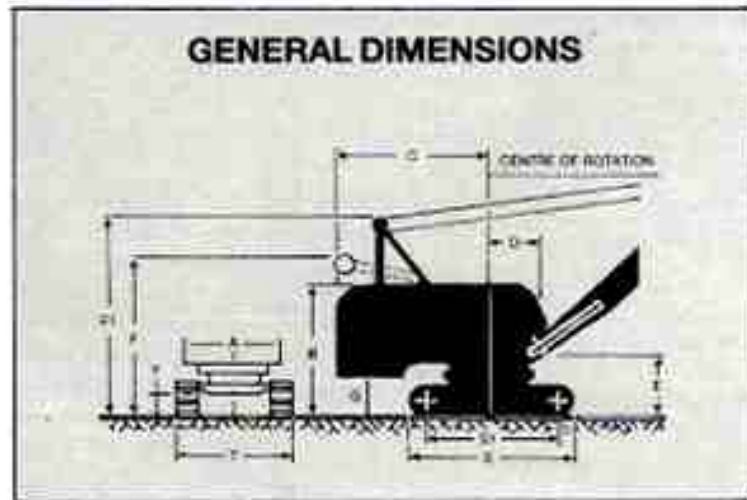

<b>A</b>	— Width of cab	3.20 m
<b>B</b>	— Height of cab top	3.61 m
<b>C</b>	— Radius of rear end (Counterweight)	4.66 m
<b>D</b>	— Centre of rotation to boom foot pin	1.28 m
<b>E</b>	— Height from ground to boom foot pin	1.93 m
<b>F</b>	— Clearance height over high gantry – Folded	3.96 m
<b>F1</b>	— Clearance height over gantry (working position)	5.94 m
<b>G</b>	— Counterweight ground clearance	1.594 m
<b>S</b>	— Overall length of crawlers	5.61 m
<b>S1</b>	— Centre distance between sprockets	4.63
<b>T</b>	— Overall width of crawlers with 914 mm std. shoes	4.47 m
<b>Y</b>	— Ground clearance of carbody (lowest point)	254 mm



Manufactured by  
**TATA ENGINEERING & LOCOMOTIVE COMPANY LIMITED**  
 at their Jamshedpur Works

Sales HO: World Trade Centre, 26th Floor, Cuffe Parade, Bombay 400 005. Tel: (022) 2186512/13/14

#### Regional Offices:

106, Ulsoor Road,  
**BANGALORE 560 042.**  
 Tel: (080) 5586560/  
 5588860

Poonam Chambers,  
 Dr. Annie Besant Road,  
 Worli,  
**BOMBAY 400 018.**  
 Tel: (022) 4938853/  
 4938865

Apojay House,  
 15, Park Street,  
**CALCUTTA 700 016.**  
 Tel: (033) 290503/294088

Jeevan Tara,  
 Parliament Street,  
**NEW DELHI 110 001.**  
 Tel: (011) 3733392/311435

#### Other Offices:

Shimoni,  
 Near Old Sama Jakat Naka,  
 Sama Road,  
**BARODA 390 008.**  
 Tel: (0265) 21179

Plot No. 434/4243,  
 Jaydev Nagar,  
 Lewis Road,  
**BHUBANESHWAR 751 012.**  
 Tel: C/o (0674) 55381

C/o J.M.A. Stores,  
 Katras Road,  
 Matkuna,  
**DHANBAD 826 001.**  
 Tel: (0326) 3794

Raj Vihar Complex,  
 Ground Floor,  
 Aquem, Margao,  
**GOA 403 806.**  
 Tel: (0834) 222264

3-5-926/13/1,  
 Himayatnagar,  
**HYDERABAD 500 029.**  
 Tel: (040)231531

K-3/58, Telco Town,  
**JAMSHEDPUR 831 004.**  
 Tel: (0657) 88368

481, Anna Salai,  
 Nandanam,  
**MADRAS 600 035.**  
 Tel: (044) 450606

1, Shiv Gaurav Estate,  
 Bhagvagar Layout,  
 Dharampeth,  
**NAGPUR 440 010.**  
 Tel: (0712) 520410

14-1-1/2 Nowroji Road,  
 Maharani Peta,  
**VIZAG 530 002.**  
 Tel: (0891) 62114

The specifications are subject to change without notice.  
 Please contact our nearest office for new specification.



**MOVING MOUNTAINS, BUILDING NATION – OUR BUSINESS WITH YET WIDER RANGE AND VARIETY**